

Burner control unit BCU 46x, 480

OPERATING INSTRUCTIONS

Cert. Version 03.19 · Edition 02.23 · EN · 03251582



1 SAFETY

1.1 Please read and keep in a safe place



Please read through these instructions carefully before installing or operating. Following the installation, pass the instructions on to the operator. This unit must be installed and commissioned in accordance with the regulations and standards in force. These instructions can also be found at www.docuthek.com.

1.2 Explanation of symbols

1, 2, 3, a, b, c = Action

→ = Instruction

1.3 Liability

We will not be held liable for damage resulting from non-observance of the instructions and non-compliant use.

1.4 Safety instructions

Information that is relevant for safety is indicated in the instructions as follows:

⚠ DANGER

Indicates potentially fatal situations.

⚠ WARNING

Indicates possible damage to life and limb.

⚠ CAUTION

Indicates possible material damage.

All interventions may only be carried out by qualified gas technicians. Electrical interventions may only be carried out by qualified electricians.

1.5 Conversion, spare parts

All technical changes are prohibited. Only use OEM spare parts.

CONTENTS

1 Safety	1
2 Checking the usage	2
3 Installation	3
4 Replacing the power module/bus module/ parameter chip card	4
5 Cable selection and installation	5
6 Wiring	5
7 Connection diagram	7
8 Adjustment	13
9 Commissioning	14
10 Manual mode	15
11 Assistance in the event of malfunction	16
12 Reading off the flame signal, fault messages and the parameters	26
13 Parameters and values	27
14 Legend	30
15 Technical data	31
16 Safety instructions	32
17 Logistics	32
18 Accessories	33
19 Certification	34
20 Disposal	35

2 CHECKING THE USAGE

Burner control units BCU 460, 465 and 480 are designed to control, ignite and monitor gas burners in intermittent or continuous operation. They replace the local control cabinet. Air and gas flow monitoring as an option.

The outputs for controlling the burners, e.g. for actuator and valves, are activated via the replaceable power module LM 400. All the parameters required for operation are saved on the integrated parameter chip card.

BCU 460, BCU 465

For directly ignited burners of unlimited capacity.

BCU 480

For pilot and main burners of unlimited capacity.

Pilot and main burners can be monitored independently.

LM..F0

Power module without air control interface.

LM..F1, LM..F3

Power module with air control interfaces to connect an air valve (LM..F3) or actuator IC 40 (LM..F1).

This function is only guaranteed when used within the specified limits – see page 31 (15 Technical data). Any other use is considered as non-compliant.

2.1 Type code

BCU 46x, BCU 480

BCU	Burner control unit
4	Series 400
60	Standard version
65	Extended air control
80	Version for pilot and main burners
Q	Mains voltage 120 V AC, 50/60 Hz
W	Mains voltage 230 V AC, 50/60 Hz
0	Ignition transformer
1	Ignition transformer, 5 kV, 15 mA, 100% duty cycle
2	Ignition transformer, 8 kV, 20 mA, 19% duty cycle
3	Ignition transformer, 8 kV, 12 mA, 100% duty cycle
8	Ignition transformer, 8 kV, 20 mA, 33% duty cycle
P0	No flange plate
P1	Flange plate: standard
P2	Flange plate: M32
P3	Flange plate: 16-pin industrial plug connector
P6	Flange plate: PROFIBUS
P7	Flange plate: conduit
C0	Without valve proving system
C1	Valve proving system: TC and POC
C2	Valve proving system: POC
D0	No high temperature operation
D1	High temperature operation
D2	Flameless operation
0	No input function

1	Input function: Auxiliary gas
2	Input function: LDS
3	Input function: auxiliary gas and LDS
0	No pressure switches
1	Pressure switch for air
2	Pressure switch for gas
3	Pressure switches for gas and air
0	
K0	No connection plugs
K1	Connection plugs with screw terminals
K2	Connection plugs with spring force terminals
E0-	Energy supply: via safety interlocks
E1-	Energy supply: via L1
LM 400	
LM	Power module
400	Series 400
Q	Mains voltage: 120 V AC, 50/60 Hz
W	Mains voltage: 230 V AC, 50/60 Hz
F0	Air actuator: none
F1	Air actuator: with IC 40 interface
F3	Air actuator: with air valve control
O0	Optional output: none
O1	Optional output: not fail-safe
O2	Optional output: fail-safe
E0-	Energy supply: via safety interlocks
E1-	Energy supply: via L1

2.2 Part designations

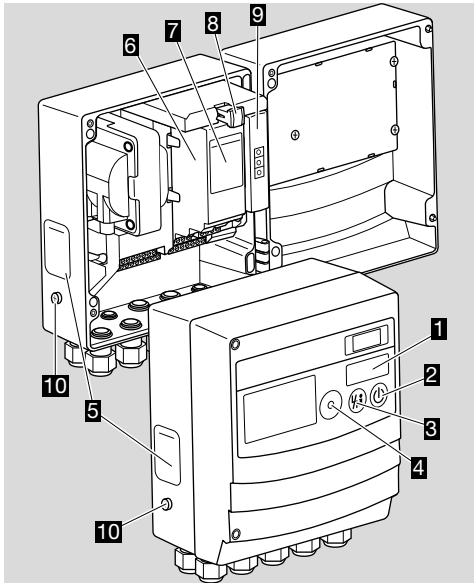

- 1 LED display for program status and fault messages
 - 2 On/Off button
 - 3 Reset/Information button
 - 4 Connection for opto-adaptor
 - 5 BCU type label
 - 6 Power module, replaceable
 - 7 Power module type label
 - 8 Parameter chip card, replaceable
 - 9 Bus module, replaceable
 - 10 M5 screw terminal for burner ground
- Type designation (**A**), identification number (**B**), construction stage (**C**), year/week of manufacture (**D**), device number (**E**), device ID (**F**), voltage (**G**), frequency (**H**), ambient temperature in Celsius (**I**)/ Fahrenheit (**J**), enclosure (**K**) – see type label.

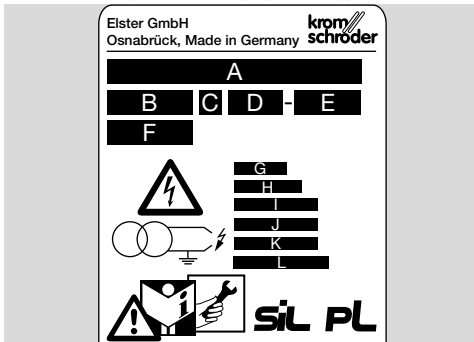

3 INSTALLATION

⚠ CAUTION

Please observe the following to ensure that the BCU is not damaged:

- The device must not be installed in a public place. It must be accessible to authorized personnel only. Unauthorized personnel could make changes which could cause the system to become unsafe or dangerous.
- Dropping the device can cause permanent damage. In this event, replace the entire device and associated modules.

→ The following components are sealed: **1** upper housing section, **2** power module, **3** bus module, **4** HMI. The BCU may only be installed and operated with undamaged seals.

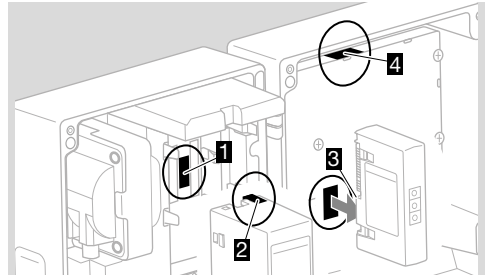

→ Installation position: vertical (cable glands pointing downwards) or down flat.

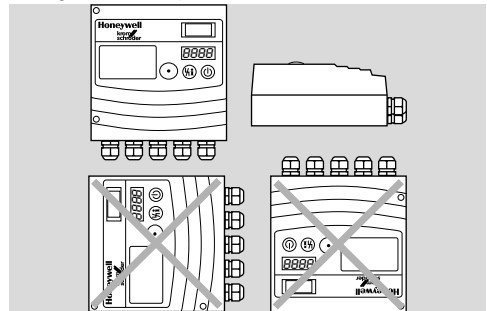

→ Distance between BCU and burner: recommended < 1 m (3.3 ft), max. 5 m (16.4 ft).

→ Affix the sticker (with the program step/fault message description) in the required language (available as an accessory).

3.1 Screwing on the BCU

From inside:

- 1 Open the cover of the BCU.

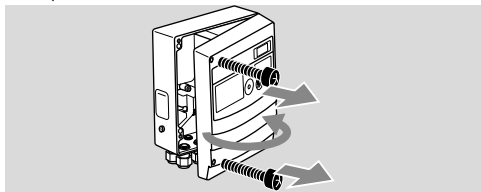

- 2 Screw on the BCU with four screws, Ø 4 mm, min. length 15 mm.

Or

To the rear:

→ The unit remains closed.

- 1 Attach the BCU with four self-tapping screws.

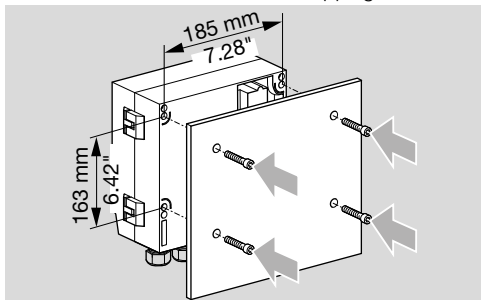

→ Self-tapping screws (M6 x 20 mm) are supplied with the unit.

→ Other mounting options are available as accessories:

Mounting	Order No.
Fastening set	74960422
External securing bars	74960414

3.2 Identification

→ Each burner control unit can be labelled individually.

- 1 Pull out the labelling plate at the top right of the housing.

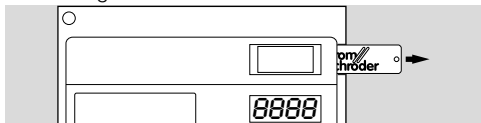

- 2 Label as required and slide back in.

4 REPLACING THE POWER MODULE/BUS MODULE/PARAMETER CHIP CARD

⚠ CAUTION

Please observe the following to ensure that the BCU is not damaged:

- **Different power supply** for the gas valves. The following combinations of BCU and LM are allowed:

BCU 4xx..E1 + LM..E1:

power supply via L1,

BCU 4xx..E0 + LM..E1:

power supply via terminal 35,

power supply for air outputs via L1,

BCU 4xx..E0 + LM..E0:

power supply via terminal 35.

- 1 Disconnect the unit from the electrical power supply.

- 2 Open the cover of the BCU.

- 3 Remove the connection plug from the power and bus module.

→ Power module and bus module are secured in the BCU by retaining lugs **A**. The retaining lugs must be pushed away from the respective module carefully so that the power or bus module can be removed.

- 4 Remove the modules in the following order to facilitate handling:

1. power module,
2. bus module,
3. parameter chip card (PCC).

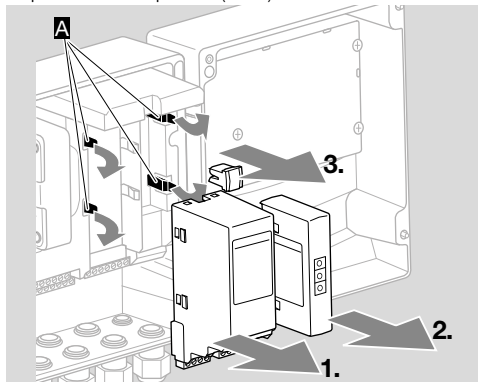

→ Installation of the modules in reverse order.

5 CABLE SELECTION AND INSTALLATION

- Signal and control line for screw terminals max. 2.5 mm² (min. AWG 24, max. AWG 12), for spring force terminals max. 1.5 mm² (min. AWG 24, max. AWG 12).
- For the ionization and ignition cables, use un-screened high-voltage cable:
FZLSi 1/7 up to 180°C,
Order No. 04250410, or
FZLK 1/7 up to 80°C,
Order No. 04250409.
- The control lines must be selected in accordance with local/national regulations.
- External electrical interference must be avoided.
- Do not route BCU cables in the same cable duct as frequency converter cables or cables emitting strong fields.

Ionization cable, UV cable

- Cable length:
for internal ignition max. 5 m (16.4 ft), for external ignition (double-electrode operation or UV control) max. 50 m (164 ft); observe the requirements of the ignition transformer.
- The flame signal is adversely affected by EMC influences.
- Lay cables individually (with low capacitance) and, if possible, not in a metal conduit.

PROFIBUS, PROFINET, EtherNet/IP

- Use only cable and plug components which comply with the appropriate fieldbus specifications.
- PROFIBUS, PROFINET and EtherNet/IP are unencrypted fieldbus protocols without authentication mechanisms.
- Use shielded RJ45 plugs.
- Cable length: max. 100 m between 2 subscribers.
- PROFINET/PROFIBUS installation guidelines, see www.profibus.com.
- Ethernet installation guidelines, see www.odva.org.

6 WIRING

⚠ CAUTION

Please observe the following to ensure that the BCU is not damaged:

- Burner ground must be connected to the BCU in order to avoid uncontrolled spark formation, especially in the case of single-electrode operation.
- **Different power supply** for the gas valves. The following combinations of BCU and LM are allowed:
BCU 4xx..E1 + LM..E1:
power supply via L1,
BCU 4xx..E0 + LM..E1:
power supply via terminal 35,
power supply for air outputs via L1,
BCU 4xx..E0 + LM..E0:
power supply via terminal 35.
- For use in an ungrounded mains system or for mains supply between phases, install an isolating transformer with single-side grounding.

- Do not reverse phase L1 and neutral conductor N.
- Do not connect different phases of a three-phase current system to the inputs.
- Check the following screw connections for the correct tightening torque so as to ensure safe grounding of housing, cover, (connection) flange plate and electronics unit as well as a good PE (ground) wire connection between the BCU and burner:

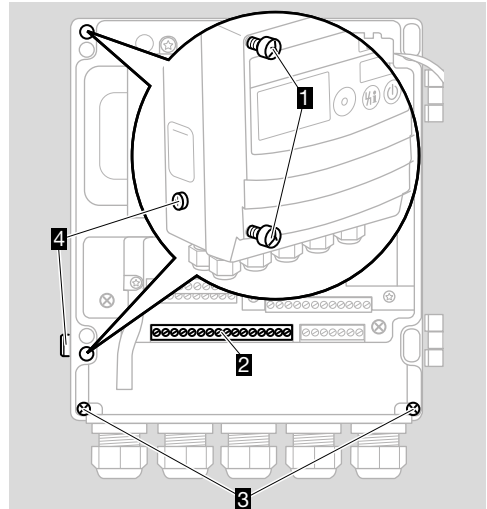

- 1 Cover screws: 2.4 Nm
- 2 Protective earth and functional earth connections
- 3 Flange plate screws: 2.4 Nm
- 4 M5 screw terminal for burner ground: 1.8 Nm

- Use plastic cable glands/conduit couplings with multiple cable grommet. These can be detached with the plug-in connection terminals.
- Do not supply voltage to the outputs.
- A short-circuit on the outputs causes one of the replaceable fuses to trip.
- Do not set the remote reset so that it operates (automatically) in cycles.
- Wire the safety circuit inputs via contacts (relay contacts) only.
- The limiters in the safety interlock (e.g. safety temperature limiter, emergency stop) must isolate terminal 35, as well as the optional safety-relevant inputs, e.g. at terminals 36 to 41, if these are parameterized, from the voltage supply. If the safety interlock is interrupted, the display shows a blinking 5f as a warning signal and all of the BCU's gas valve outputs are disconnected from the electrical power supply.
- Connected control elements must be equipped with protective circuits in accordance with the manufacturer's instructions. The protective circuit prevents high voltage peaks which can cause malfunctioning of the BCU.
- Install the ignition cable in the BCU in the designated cable duct **1** and feed it out of the BCU on the shortest possible route via the cable gland **2**.

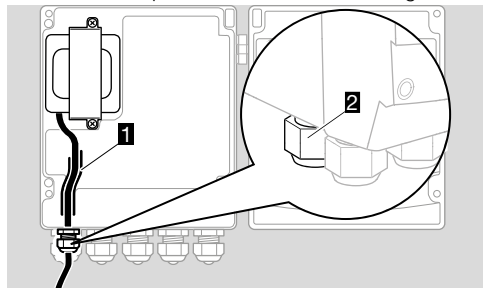

- Observe the maximum duty cycle for the ignition transformer (see manufacturer's instructions). Adjust the minimum pause time t_{MP} (parameter A062) correspondingly, if required.
- All functions of the inputs at terminals 1 to 7 and 35 to 41, as well as of contacts 80 to 82, 85 to 87, 90 to 92 and 95 to 97, depend on parameters I050 to I074.
- 1** Disconnect the system from the electrical power supply.
- 2** Before wiring, ensure that the yellow parameter chip card has been inserted in the BCU.

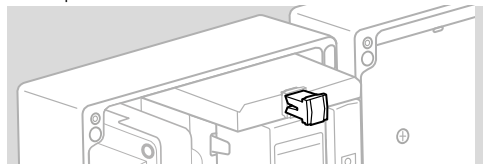

- Screw terminals or spring force terminals are available for the BCU:

Screw terminals, Order No. 74924876.

Spring force terminals, Order No. 74924877.

- 3** Wire as shown on the connection diagram – see page 7 (7 Connection diagram).
- 4** After wiring, close the housing cover again and tighten the cover screws to 2.4 Nm.

7 CONNECTION DIAGRAM

BCU 460/LM..F0

→ The connection diagram shows BCU..E1 with LM..E1.

→ Legend – see page 30 (14 Legend).

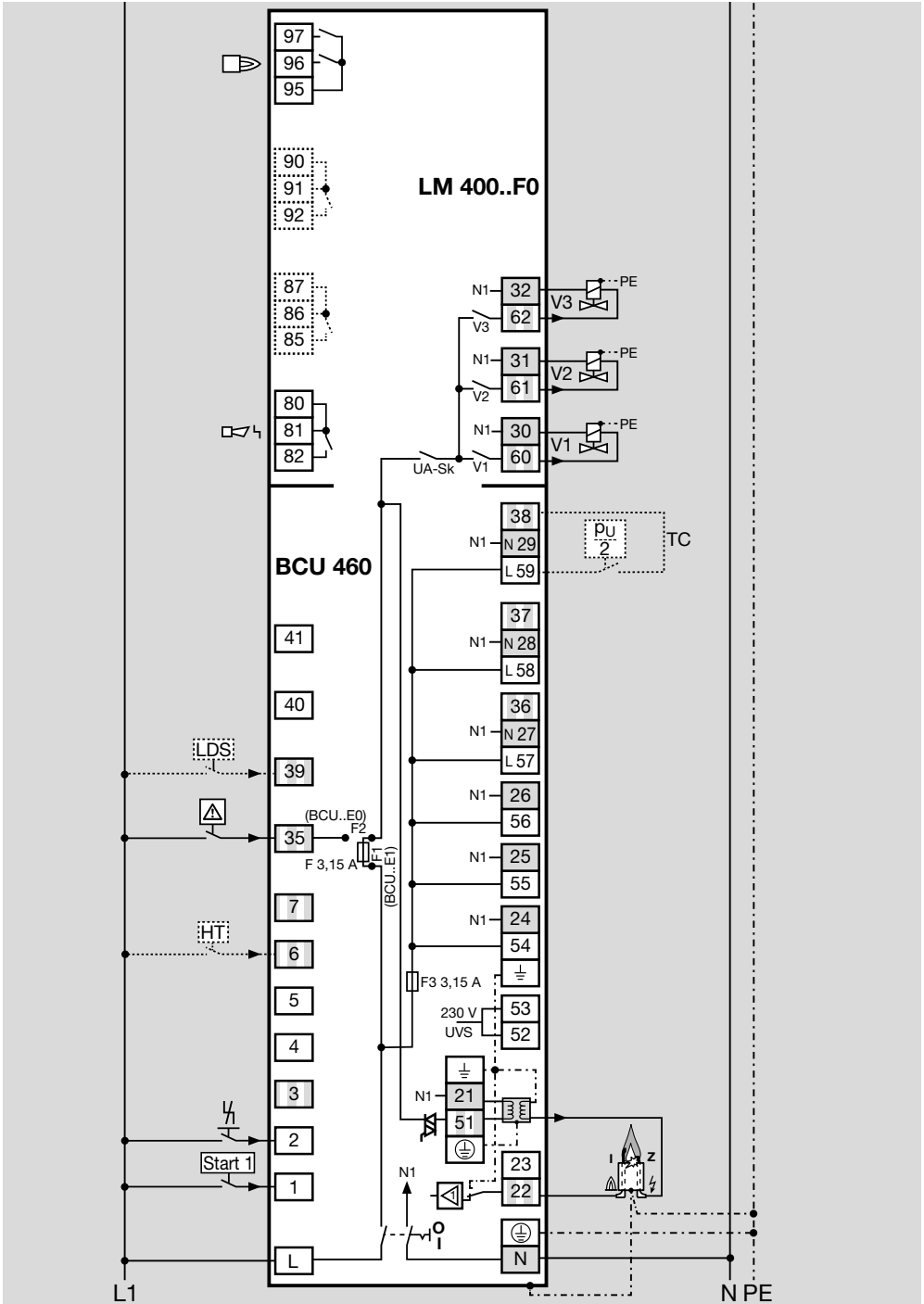

BCU 460/LM..F3

→ Legend – see page 30 (14 Legend).

→ The connection diagram shows BCU..E1 with LM..E1.

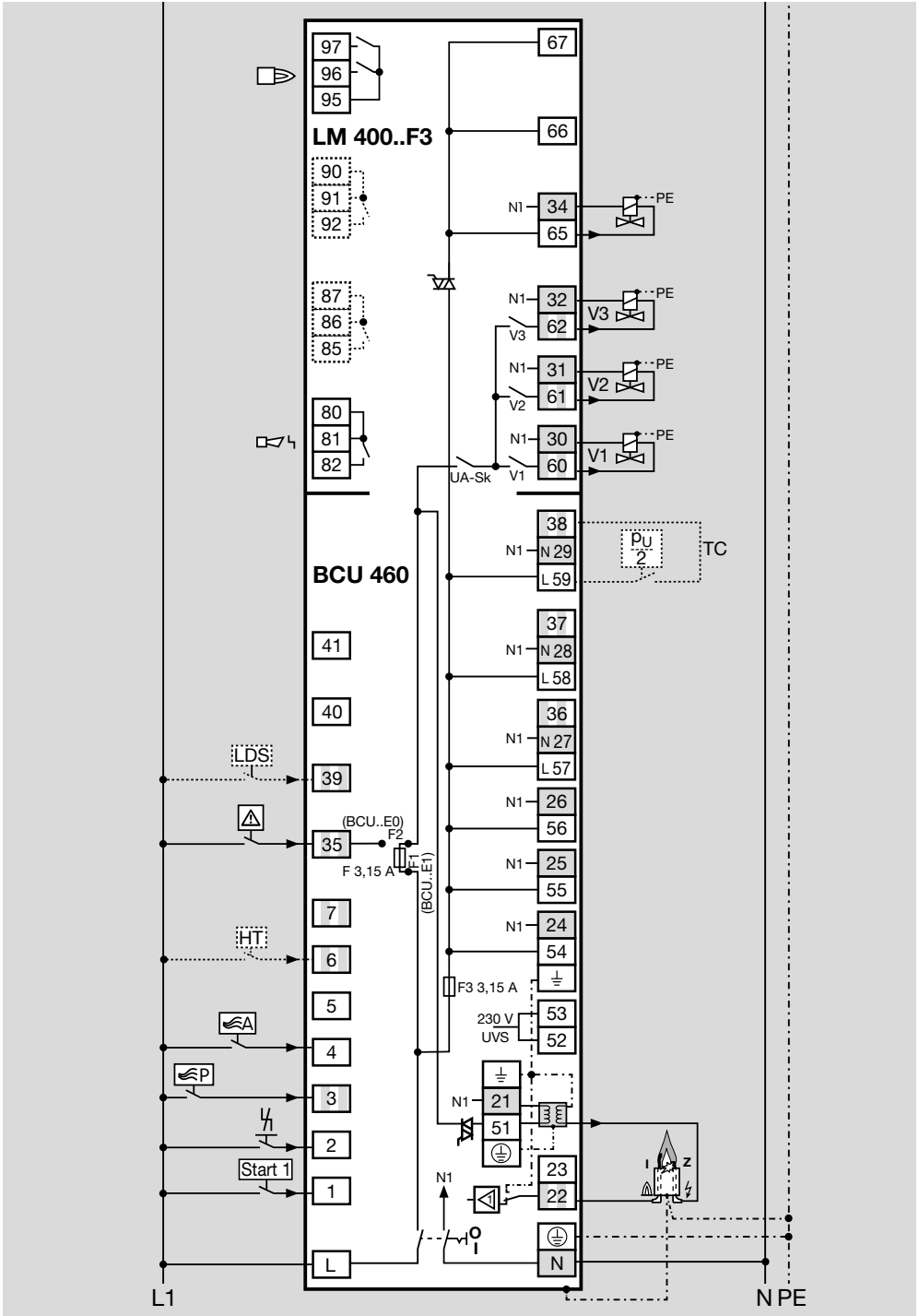

BCU 465/LM..F3

→ Legend – see page 30 (14 Legend).

→ The connection diagram shows BCU..E1 with LM..E1.

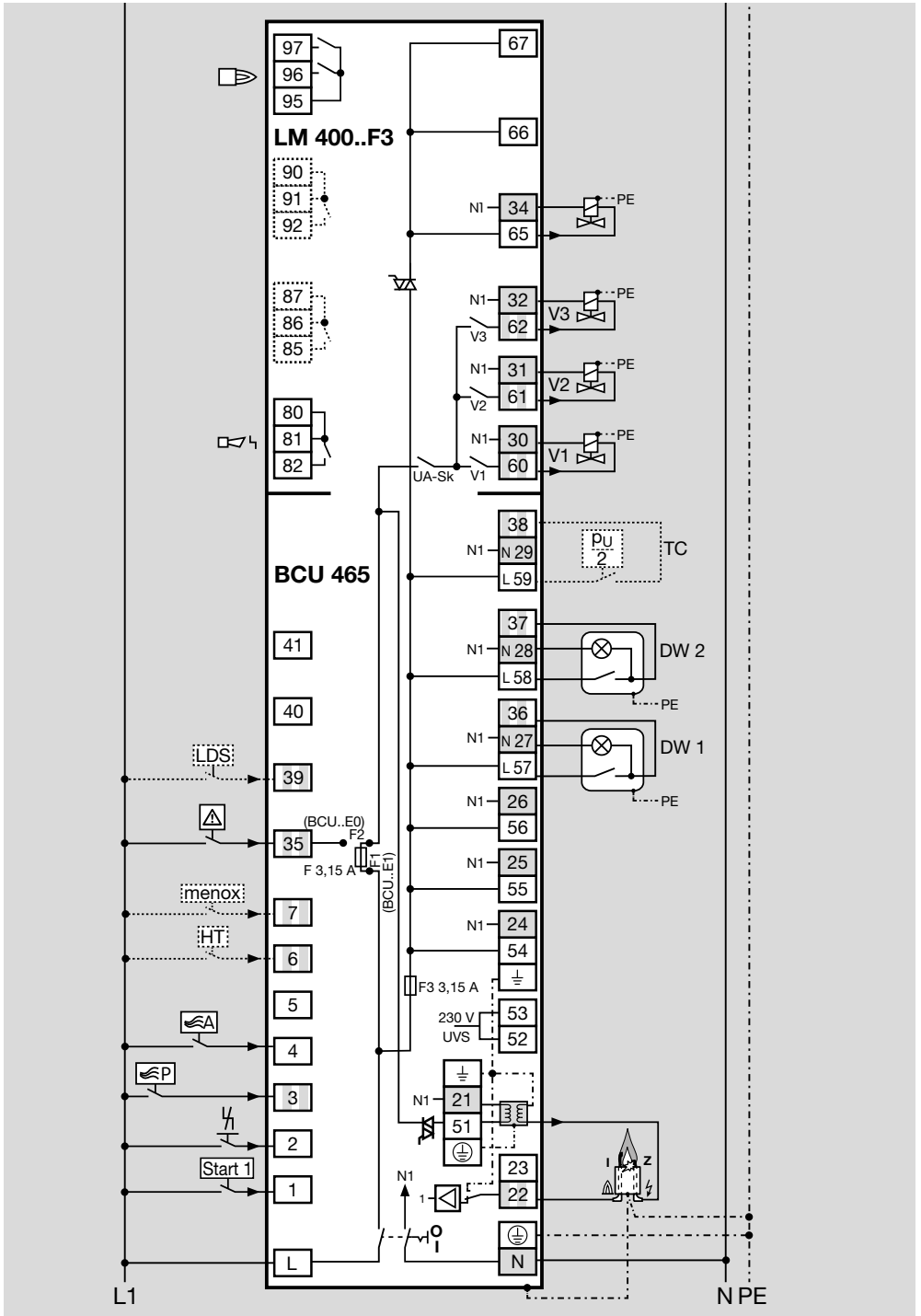

BCU 480/LM..F3

→ Legend – see page 30 (14 Legend).

→ The connection diagram shows BCU..E1 with LM..E1.

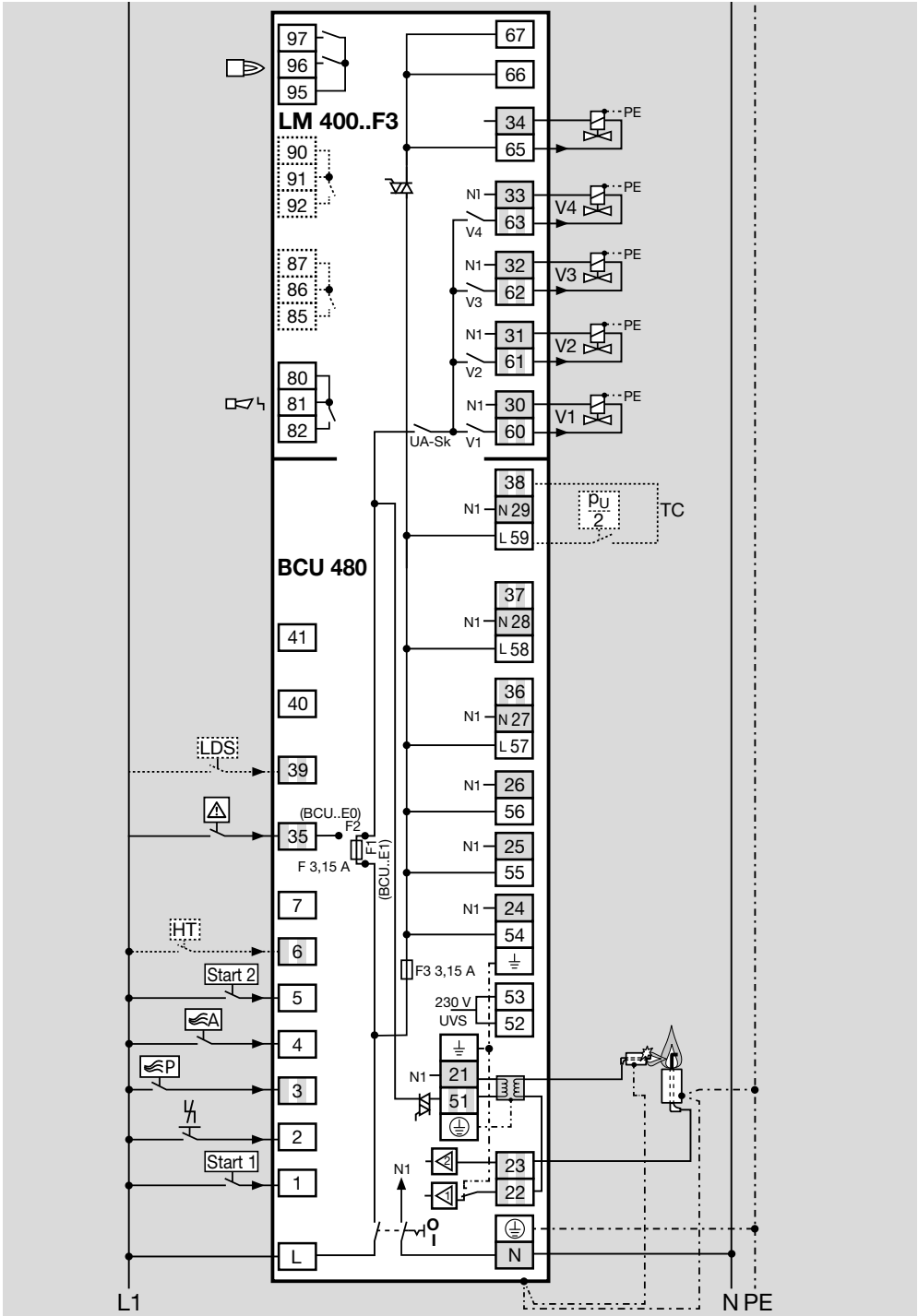

BCU..P3 with industrial plug connector

Terminal assignment		
Terminal	Function	BCU
2	Burner 2 operating signal	97
3	External air control	4
4	Purge	3
5	Burner 2 start	5
6	High temperature	6
7	Safety interlocks (limits)	35
8	Burner 1 start	1
9	NO fault signalling contact	82
10	NO fault signalling contact	80
11	Supply voltage for operating signals	95
12	Burner 1 operating signal	96
14	Remote reset	2
15	Neutral conductor	N
16	Phase	L
PE	PE wire	PE

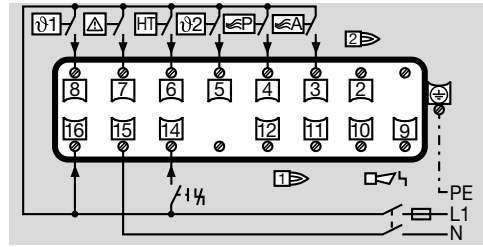

IC 40 connected to BCU/LM..F1 (staged control)

Parameter IO20 = 2.

Set IC 40 to operating mode 11,
see Actuator IC 40 operating instructions or
technical information bulletin at www.docuthek.com.

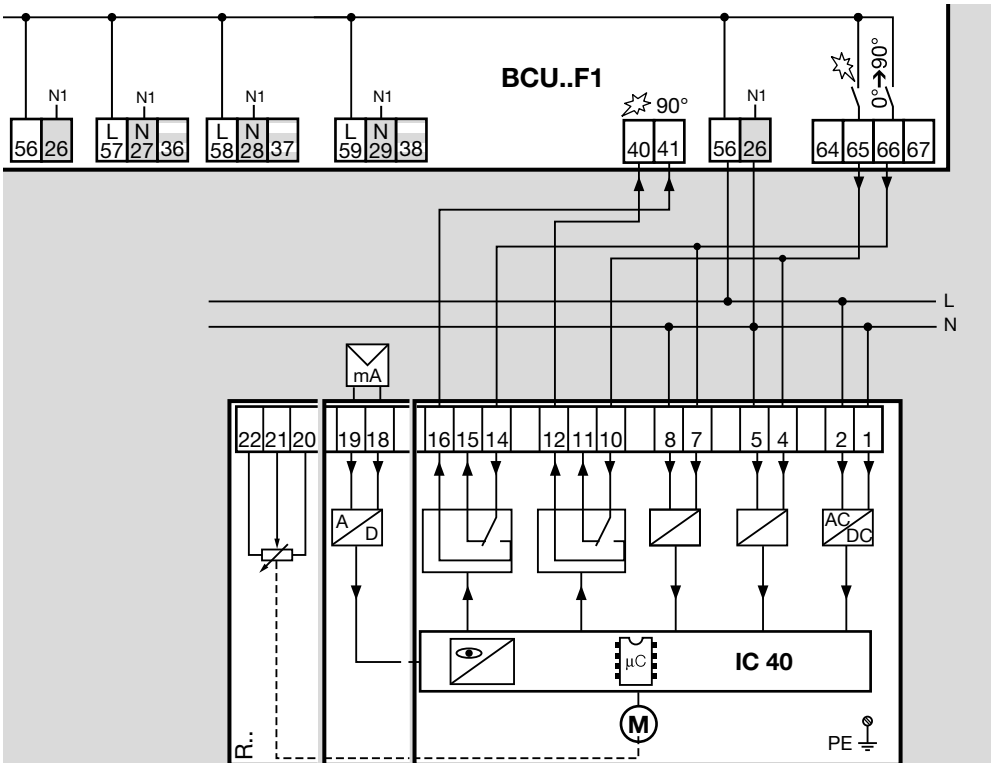

Flame control

- BCU 460, 465 = 1 flame amplifier
- BCU 480 = 2 flame amplifiers
- In the case of UV control, use Elster UV sensors for intermittent operation (UVS 5, 10) or flame detectors for continuous operation (UVC 1).

BCU 460, 465

Double-electrode operation

- See page 7 (7 Connection diagram), BCU 460/LM..F0, BCU 460/LM..F3 and BCU 465/LM..F3.

Ionization/single-electrode operation:

- Parameter I004 = 0.

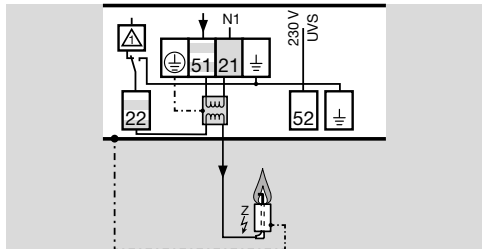

UV control:

UVS 5, 10

- Parameter A001 ≥ 5 µA.
- Parameter I004 = 1.

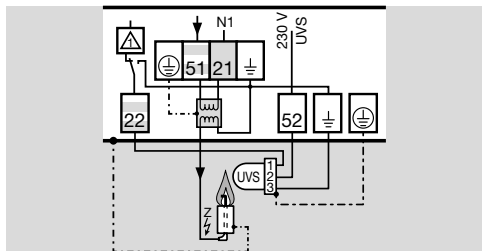

UVC 1

- Parameter I004 = 2.

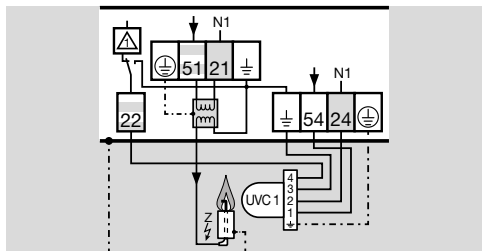

BCU 480

**Pilot burner = double-electrode operation/
main burner = ionization:**

- Pilot burner in double-electrode operation
- Ionization control for main burner
- Parameter I004 = 0.

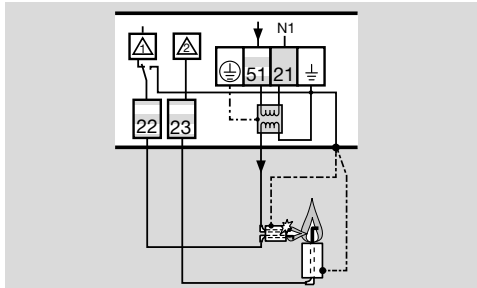

**Pilot burner = single-electrode operation/
main burner = ionization:**

- Pilot burner in single-electrode operation
- Ionization control for main burner
- Parameter I004 = 0.

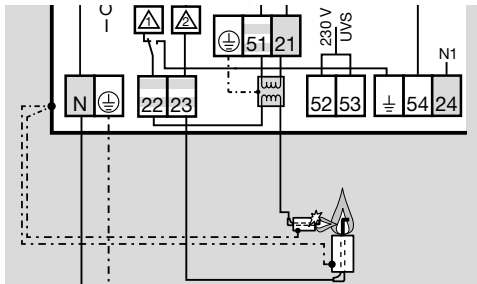

**Pilot burner = single-electrode operation/
main burner = UVS:**

- Parameter A001 ≥ 5 µA.
- Parameter I004 = 3.

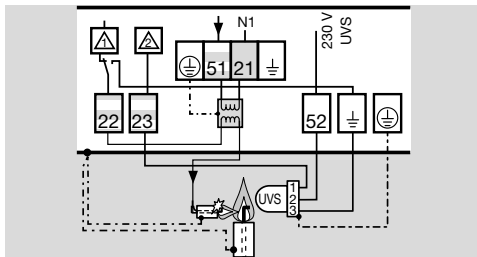

Pilot burner = single-electrode operation/main burner = UVC 1:

→ Parameter I004 = 4.

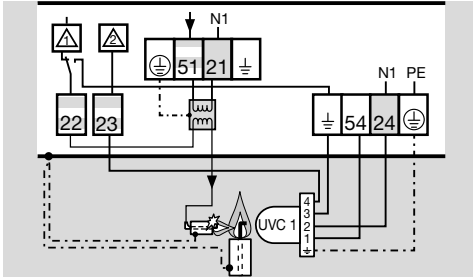

Pilot burner = UVS/main burner = ionization:

→ Parameter A002 $\geq 5 \mu\text{A}$.

→ Parameter I004 = 5.

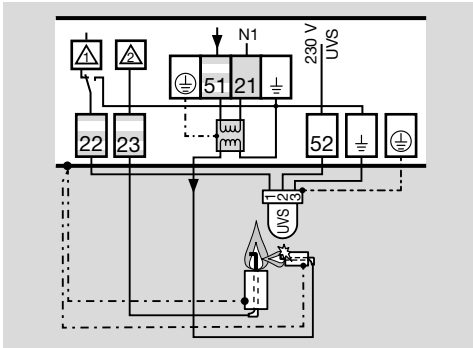

Pilot burner = UVC/main burner = UVC:

→ Parameter I004 = 2.

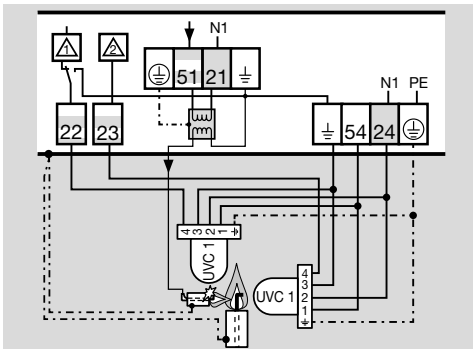

Pilot burner = UVC/main burner = ionization:

→ Parameter I004 = 7.

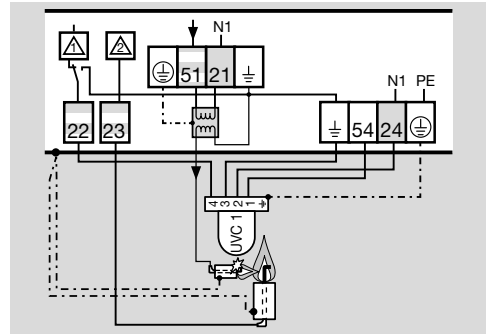

Pilot burner = UVC/main burner = UVS:

→ Parameter A002 $\geq 5 \mu\text{A}$.

→ Parameter I004 = 8.

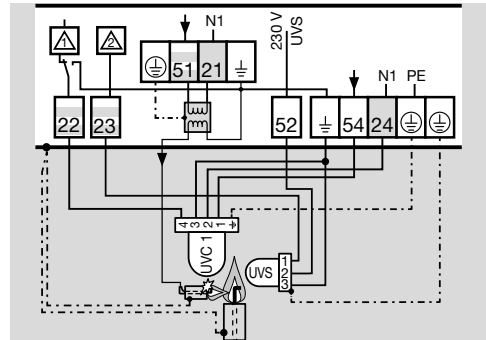

8 ADJUSTMENT

In certain cases, it may be necessary to change the parameters set at the factory. The parameters on the BCU, such as the safety time or the behaviour in the event of a flame failure, can be modified using the separate software package BCSoft and an opto-adapter.

1 Set the parameters using BCSoft.

→ For reasons of network security, it is not possible to access the unit via the network using BCSoft.

→ The software package and the opto-adapter are available as accessories.

→ Changed parameters are saved on the integrated parameter chip card.

→ The factory settings are secured with a programmable password. The default password is 1234. We recommend changing the password upon commissioning.

→ Hardware parameters (e.g. type of flame control or type of air actuator) are set via interface parameters I004 to I074.

→ Once parameters have been changed, a check is automatically carried out to ensure that the changes have been accepted and the display shows "UrFy".

- 2 Press the Reset/Information button on the BCU.

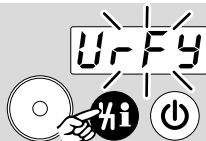

- The first parameter value that was changed is displayed.

- 3 Press the Reset/Information button again.

- The next parameter value that was changed is displayed.

- Repeat this procedure until "rdY" is displayed.

- 4 Press the Reset/Information button on the BCU to confirm the new parameter settings.

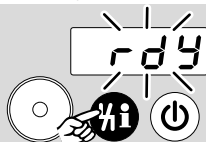

9 COMMISSIONING

- During operation, the 7-segment display shows the program status:

00	Standby
H0	Delay
Rc	Approaching minimum capacity
R0	Cooling
01	Fan run-up time
R1	Pre-ventilation
R0	Approaching maximum capacity
H1	Delay
P0	Pre-purge
P1	Pre-purge
R1	Approaching ignition capacity
tc	Valve check
02	Safety time 1 t_{SA1}
R2	Safety time 1 t_{SA1}
03	Flame proving period 1 t_{FS1}
R3	Flame proving period 1 t_{FS1}
04	Burner 1 operation
R4	Burner 1 operation
05	Burner 2 waiting time
R5	Delay
H5	Delay time during burner 2 waiting time
06	Safety time 2 t_{SA2}
R6	Safety time 2 t_{SA2}
07	Flame proving period 2 t_{FS2}
R7	Flame proving period 2 t_{FS2}
08	Burner 2 operation
R8	Burner 2 operation
H8	Delay

--	Device Off
[]	Data transfer (programming mode)
00	(blinking dots) Manual mode
l XX	Low NOx operation in program step XX
h XX	High temperature operation in program step XX

- Units with SafetyLink function (BCU with bus module BCM..S1) may only be commissioned using BCSofT. Further information can be found in Technical Information BCU 46x or BCU 480.

⚠ WARNING

Risk of explosion!

Check the system for tightness before commissioning.

Do not start the BCU until the parameter settings and wiring are correct and the faultless processing of all input and output signals complies with the local standards.

- 1 Switch on the system.

- The display indicates --.

- 2 Switch on the BCU by pressing the On/Off button.

- The display indicates 00.

- The display blinks and indicates E. A resettable fault lock-out is signalled. Reset the BCU by pressing the Reset/Information button.

- The display blinks without indicating "E". A warning message is signalled. Once the fault has been eliminated, the display stops blinking and the BCU continues the program run.

BCU 460..F0

- a Apply the start-up signal to terminal 1.

- The display indicates 01.

- The display indicates 02. The gas valves open and the burner ignites. Safety time 1 starts to elapse.

- The display indicates 03 during flame proving period 1.

- The display indicates 04. The burner is in operation.

BCU 46x..F1, BCU 46x..F3

- If the air actuator is activated externally for cooling in the start-up position, the display indicates R0.

- a Apply the start-up signal to terminal 1.

- The display indicates 01 or R1 if the air actuator has been activated.

- The display indicates 02 or R2 if the air actuator has been opened. The gas valves open and the burner ignites. Safety time 1 starts to elapse.

- The display indicates 03 during flame proving period 1 or R3 if the air actuator has been opened.

- The display indicates 04 or R4 if the air actuator has been opened. The burner is in operation.

BCU 480..F1/F3

- If the air actuator is activated externally for cooling in the start-up position, the display indicates **R0**.
- a** Apply the start-up signal to terminal 1.
- The display indicates **01** or **R1** if the air actuator has been activated.
- The display indicates **02** or **R2** if the air actuator has been opened. The gas valves open, the pilot burner (burner 1) ignites and safety time 1 starts to elapse.
- The display indicates **03** during flame proving period 1 or **R3** if the air actuator has been opened.
- The display indicates **04** or **R4** if the air actuator has been opened. The pilot burner is in operation.
- The display indicates **05** or **R5** if the air actuator has been opened. The main burner (burner 2) ignites and safety time 2 starts to elapse.
- The display indicates **07** during flame proving period 2 or **R7** if the air actuator has been opened.
- The display indicates **08** or **R8** if the air actuator has been opened. The main burner is in operation. The controller enable signal has been issued.

10 MANUAL MODE

- For adjustment of the burner control unit or for fault-finding.
- In Manual mode, the BCU operates independently of the status of the inputs for start-up signal (terminal 1), external air control (terminal 4) and remote reset (terminal 2). The function of the controller enable/emergency stop input (terminal 35) is retained.
- Manual mode is terminated by switching off the BCU or in the event of a power failure.
- Parameter A067 = 0: Manual mode unlimited in time.
- Parameter A067 = 1: the BCU will terminate Manual mode 5 minutes after the last time the Reset/Information button is pressed. It switches to the start-up position/standby (display **00**).
- 1** Switch on the BCU while holding the Reset/Information button. Hold the Reset/Information button until 4 dots start to flash in the display.

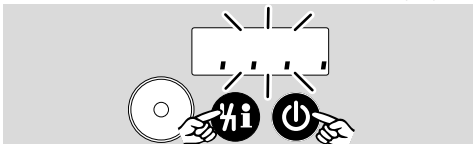

- If the Reset/Information button is pressed briefly, the current step in Manual mode is shown and “5...” is displayed.
- If the Reset/Information button is pressed for > 1 s, the BCU proceeds to the next program step.

BCU 460/LM..F0

- 1** Press the Reset/Information button for 1 s.
- The display shows “5..2.” (step 2).
- The BCU will start the first stage of the burner.
- The display runs to “.02.” or “.03.”.
- After 3 seconds in this position, the μ A value for the flame signal “XXX” is displayed instead of the program status.
- 2** Press the Reset/Information button for 1 s.
- The display shows “5..3.” (step 3).
- The BCU will start the second stage of the burner.
- The display runs to “.04.”.
- After 3 seconds in this position, the μ A value for the flame signal “XXX” is displayed instead of the program status.

BCU 46x/LM..F1/F3

- 1** Press the Reset/Information button for 1 s.
- The display shows “5..1.” (step 1).
- The BCU will start to purge the burner.
- The display indicates “.P0.”.

⚠ WARNING

Risk of explosion!

The pre-purge time is not included in the program. Maintain state **P0** until the combustion chamber has been adequately ventilated.

- 2** Press the Reset/Information button for 1 s.
- The display shows “5..2.” (step 2).
- The BCU will start the first stage of the burner.
- The display runs to “.02.” or “.03.” (an “R” rather than a “0” appears if the air actuator is activated).
- After 3 seconds in this position, the μ A value for the flame signal “XXX” is displayed instead of the program status.
- 3** Press the Reset/Information button for 1 s.
- The display shows “5..3.” (step 3).
- The BCU will start the second stage of the burner.
- The display runs to “.04.” (“R4”).
- After 3 seconds in this position, the μ A value for the flame signal “XXX” is displayed instead of the program status.

Air actuator control:

The air actuator is activated externally (parameter A048 = 0).

- a** Press the Reset/Information button for 1 s.
- The display shows “5..4.” (step 4).
- The BCU will open the air actuator.
- Each time the button is pressed, the air actuator is closed or opened again.

The air actuator opens under program control (parameter A048 = 1, 2, 3, 4, 5 or 6).

- The air actuator opens under program control with valves V1, V2, V3 or when it reaches the operating position.
- a** Press the Reset/Information button for 1 s.
- The display shows “5..4.” (step 4).

→ The BCU will start the shut-down procedure.

BCU 480

- 1 Press the Reset/Information button for 1 s.
 - The display shows “5..1.” (step 1).
 - The BCU will start to purge the burner.
 - The display indicates “.P.Q.”.

⚠ WARNING

Risk of explosion!

The pre-purge time is not included in the program. Maintain state P.Q. until the combustion chamber has been adequately ventilated.

- 2 Press the Reset/Information button for 1 s.
 - The display shows “5..2.” (step 2).
 - The BCU will start the pilot burner.
 - The display runs to “.Q.4.” (an “R” rather than a “B” appears if the air actuator is activated).
 - After 3 seconds in this position, the μ A value for the flame signal “XXX” is displayed instead of the program status.
- 3 Press the Reset/Information button for 1 s.
 - The display shows “5..3.” (step 3).
 - The BCU will start the first stage of the main burner.
 - The display runs to “.Q.B.”.
 - After 3 seconds in this position, the μ A value for the flame signal “XXX” is displayed instead of the program status.

Air actuator control:

The air actuator is activated externally (parameter A048 = 0).

- a Press the Reset/Information button for 1 s.
 - The display shows “5..4.” (step 4).
 - The BCU will open the air actuator.
 - The display indicates “.R.4.”.
 - Each time the button is pressed, the air actuator is closed or opened again.
 - Press the On/Off button to switch the unit off.

The air actuator opens under program control (parameter A048 = 1, 2, 3, 4, 5 or 6).

- The air actuator opens under program control with valves V1, V2, V3, V4 or when it reaches the operating position.
- If the Reset/Information button is pressed for 1 s, the display shows “5..4.” (step 4) and the BCU starts the shut-down procedure.

11 ASSISTANCE IN THE EVENT OF MALFUNCTION

⚠ DANGER

To avoid harm to persons and damage to the unit, please observe the following:

- Electric shocks can be fatal! Before working on possible live components, ensure the unit is disconnected from the power supply.
- Fault-clearance must only be undertaken by authorized trained personnel.

→ Faults may be cleared only using the measures described below.

- If the BCU does not respond even though all faults have been remedied: remove the unit and return it to the manufacturer for inspection.
- The display blinks and indicates “E”. A resettable fault lock-out is signalled. In the event of a fault lock-out, the fault signalling contact closes, the display blinks and shows the current program step. The gas valves are disconnected from the electrical power supply.
- After a fault lock-out, the BCU must be reset manually using the button on the front panel or the remote reset input (terminal 2).
- The BCU cannot be reset by mains failure (non-volatile fault lock-out). The fault signalling contact does, however, open as soon as the mains voltage fails.
- The display blinks without indicating “E”. A warning message is signalled. Once the fault has been eliminated, the display stops blinking and the BCU continues the program run.

? **Faults**

! Cause

- Remedy

? **The 7-segment display does not light up.**

! Mains voltage is not applied.

- Check the wiring, apply mains voltage (see type label).



? **The display blinks and indicates E 01 or E R1.**

! The BCU has detected an incorrect flame signal without the burner having been ignited (extraneous signal).

- Direct the UV sensor exactly at the burner to be monitored.

! UV tube in the UV sensor is defective (service life ended) and issues a continuous flame signal.

- Replace the UV tube, see UV sensor operating instructions.

! Flame signal through conductive ceramic insulation.

- Increase value of parameter A001 in order to adapt the switch-off threshold of the flame amplifier for burner 1.



? **Start-up – no ignition spark – the display blinks and indicates E 02 or E R2.**

! The ignition cable is too long.

- Shorten it to 1 m (max. 5 m).

- ! Gap between spark electrode and burner head is too great.
 - Adjust gap to max. 2 mm.
- ! Ignition cable has no contact in the terminal boot.
 - Screw the cable on firmly.
- ! Ignition cable has no contact in the ignition transformer.
 - Check the connection.
- ! Ignition cable has short-circuited to ground.
 - Check installation, clean the spark electrode.
 - If the fault cannot be remedied by doing this, remove the unit and return it to the manufacturer for inspection.

? Start-up without flame – no gas supply – the display blinks and indicates E 02 or E R2.

- ! A gas valve does not open.
 - Check the gas pressure.
 - Check voltage supply to the gas valve.
- ! There is still air in the pipe, e.g. after installation work has been carried out or if the system has not been in operation for a long period.
 - “Purge” the pipeline and reset the BCU.
 - If the fault cannot be remedied by doing this, remove the unit and return it to the manufacturer for inspection.

? Start-up – pilot/burner flame burning – nevertheless, the display blinks and indicates E 02 or E R2.

- ! Flame failure on start-up.
 - Read off the flame signal.
- ! Incorrect wiring for single-electrode operation.
 - Check the wiring for single-electrode operation, see page 12 (Flame control).
 - If the fault cannot be remedied by doing this, remove the unit and return it to the manufacturer for inspection.

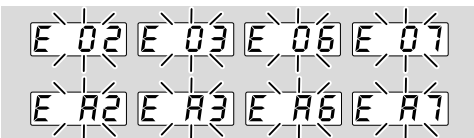

? Start-up – flame burning – nevertheless, the display blinks and indicates E 02 or E 03 on the pilot burner/burner (burner 1) or E 06 or E 07 on the main burner (burner 2).

- ! Flame failure on start-up.
 - Read off the flame signal.
- If the flame signal is lower than the switch-off threshold for the flame signal from burner 1 (parameter A001) or burner 2 (parameter A002), this may be attributable to the following causes:
 - ! The set value for the cut-off sensitivity is too high.
 - ! Short-circuit on the flame rod as the result of soot, dirt or moisture on the insulator.

- ! Flame rod not correctly positioned at the flame edge.
- ! Terminal boot not properly connected to flame rod.
- ! Gas/air ratio incorrect.
- ! Flame not contacting burner ground as the result of excessively high gas or air pressure.
- ! Burner or BCU not (adequately) grounded.
- ! Short-circuit or discontinuity on the flame signal cable.
- ! Soiled UV sensor.
- ! UV sensor wiring is defective.
 - Remedy fault.

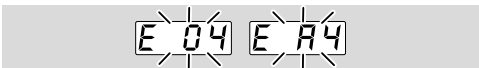

? Operation – flame burning – burner 1 interrupted – the display blinks and indicates E 04 or E R4.

- ! Flame failure during operation.
 - Read off the flame signal, see page 26 (12 Reading off the flame signal, fault messages and the parameters).
- If the flame signal is lower than the switch-off threshold for the flame signal from burner 1 (parameter A001), this may be attributable to the following causes:
 - ! The set value for the cut-off sensitivity is too high.
 - ! Short-circuit on the flame rod as the result of soot, dirt or moisture on the insulator.
 - ! Flame rod not correctly positioned at the flame edge.
 - ! Gas/air ratio incorrect.
 - ! Flame not contacting burner ground as the result of excessively high gas or air pressure.
 - ! Burner or BCU not (adequately) grounded.
 - ! Short-circuit or discontinuity on the flame signal cable.
 - ! Soiled UV sensor.
 - Remedy fault.

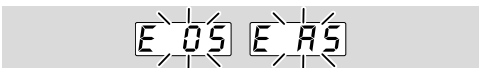

? The display blinks and indicates E 05 or E R5.

- ! The BCU has detected an incorrect flame signal without burner 2 (main burner) having been ignited (extraneous signal).
 - Direct the UV sensor exactly at burner 2 to be monitored.
- ! UV tube in the UV sensor is defective (service life ended) and issues a continuous flame signal.

- Replace the UV tube, see UV sensor operating instructions.

! Flame signal through conductive ceramic insulation.

- Increase value of parameter A002 in order to adapt the switch-off threshold of the flame amplifier for burner 2.

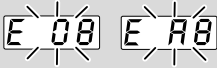

? **Operation – flame burning – burner 2 interrupted – the display blinks and indicates E 08 or E AB.**

! Flame failure during operation or during delayed controller enable.

- Read off the flame signal, see page 26 (12 Reading off the flame signal, fault messages and the parameters).

→ If the flame signal is lower than the switch-off threshold for the flame signal from burner 2 (parameter A002), this may be attributable to the following causes:

! The set value for the cut-off sensitivity is too high.

! Short-circuit on the flame rod as the result of soot, dirt or moisture on the insulator.

! Flame rod not correctly positioned at the flame edge.

! Gas/air ratio incorrect.

! Flame not contacting burner ground as the result of excessively high gas or air pressure.

! Burner or BCU not (adequately) grounded.

! Short-circuit or discontinuity on the flame signal cable.

! Soiled UV sensor.

- Remedy fault.



? **The display blinks and indicates E 10.**

! Actuation of the remote reset input is faulty.

! Too many remote resets. More than 5 resets have been conducted within the last 15 minutes, either automatically or manually.

! Consecutive fault caused by a previous fault whose actual cause has not been remedied.

- Pay attention to previous fault messages.
- Remedy cause.

→ The cause will not be remedied by performing a reset every time a fault lock-out occurs.

- Check whether remote reset complies with standards (EN 746 allows resetting only under supervision) and correct if necessary.

→ The BCU may only be reset manually under supervision.

- Press the Reset/Information button on the BCU.



? **The display blinks and indicates E 11.**

! Too many restarts for burner 1. More than 5 restarts initiated within the last 15 minutes.

- Check burner settings.

→ Ensure that the flame signal is above the switch-off threshold during operation.

- Check the settings for capacity control during operation.

- Press the Reset/Information button on the BCU.



? **The display blinks and indicates E 12.**

! Too many restarts for burner 2. More than 5 restarts initiated within the last 15 minutes.

- Check burner settings.

→ Ensure that the flame signal is above the switch-off threshold during operation.

- Check the settings for capacity control during operation.

- Press the Reset/Information button on the BCU.



? **The display blinks and indicates E 21.**

! Inputs 40 and 41 are activated simultaneously.

- Check input 41.

→ Input 41 may only be activated if the valve is open.

- Check input 40.

→ Input 40 may only be activated if the valve is in the position for ignition capacity.

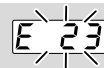

? **The display blinks and indicates E 23.**

! The butterfly valve position is not constantly signalled back to the BCU.

- Check the wiring and ensure that the position for max. capacity/ignition capacity of the butterfly valve is constantly signalled back via terminals 41 and 42.



? The display blinks and indicates E 30, E 31.

- !** Abnormal data change in the parameters set for the BCU.
 - Reset the parameters to their original values using the BCSofT software.
 - Establish the cause of the fault to avoid repeat faults.
 - Ensure that the cables have been installed properly – see page 5 (5 Cable selection and installation).
 - If the measures described above do not help, remove the unit and return it to the manufacturer for inspection.



? The display blinks and indicates E 32.

- !** Supply voltage too low or too high.
 - Operate the BCU in the specified mains voltage range (mains voltage +10/-15%, 50/60 Hz).
- !** An internal device error occurred.
 - Remove the unit and return it to the manufacturer for inspection.

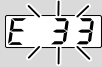

? The display blinks and indicates E 33.

- !** Faulty parameterization.
 - Check parameter settings using BCSofT and adjust them if necessary.
- !** An internal device error occurred.
 - Remove the unit and return it to the manufacturer for inspection.

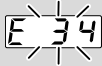

? The display blinks and indicates E 34.

- !** Faulty actuation of the air valve.
- !** Voltage is applied to the air valve outputs (65–67).
 - Check the wiring and ensure that the voltage outputs and inputs have the same polarity and are not reversed.
- !** Fuse F3 defective.
 - Replace fuse F3.
- !** An internal device error occurred.
 - Replace the power module.
 - Remove the unit and return it to the manufacturer for inspection.

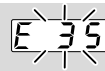

? The display blinks and indicates E 35.

- !** Bus module and control unit are incompatible.
 - Check the bus system and PLC for compatibility.
- !** Bus module does not support the selected function.
 - Check the setting of parameter A075.



? The display blinks and indicates E 36.

- !** Voltage is applied to the gas valve outputs.
 - Check the wiring and ensure that the voltage outputs and inputs have the same polarity and are not reversed.
- !** Fuses defective.
 - Replace the fuses.
- !** An internal device error occurred.
- !** An incorrect power module module is used.
 - Replace the power module.
- !** Fault caused by temporary EMC influence.
 - Ensure that the ignition cable has been installed properly – see page 5 (5 Cable selection and installation).
 - Ensure that the EMC regulations for the system are satisfied – particularly for systems with frequency converters – see page 5 (5 Cable selection and installation).
 - Remove the unit and return it to the manufacturer for inspection.

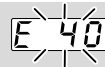

? The display blinks and indicates E 40.

- !** The gas solenoid valve V1 is leaking.
 - Check the gas solenoid valve V1.
- !** The gas pressure switch DGp_v/2 for the tightness test has been set incorrectly.
 - Check the inlet pressure.
 - Set DGp_v/2 to the correct inlet pressure.
 - Check the wiring.
- !** The test pressure between V1 and the downstream gas solenoid valve (V2, V3 or V4) has not decreased.
 - Check the installation.
- !** The test period is too long.
 - Check parameter A056 (Measurement time for V_{p1}) and change it using BCSofT.

- If the fault cannot be remedied by doing this, remove the unit and return it to the manufacturer for inspection.



? The display blinks and indicates E 41.

! The downstream gas solenoid valve (V2, V3 or V4) is leaking.

- Check the downstream solenoid valve.

! The gas pressure switch DGp_v/2 for the tightness test has been set incorrectly.

- Check the inlet pressure.
- Set DGp_v/2 to the correct pressure.
- Check the wiring.

! The test period is too long.

- Check parameter A056 (Measurement time for V_{p1}) and change using BCSoft.
- If the fault cannot be remedied by doing this, remove the unit and return it to the manufacturer for inspection.



? The display blinks and indicates E 44.

! Faulty pressure switch signal.

- Check the wiring and setting of the pressure switch/gas valve.



? The display blinks and indicates E 51.

! Signal interruption at “Safety interlock/Controller enable/Emergency stop” input (depending on the parameterization at terminal 1 to 7 or terminal 35).

- Check actuation of “Safety interlock/Controller enable/Emergency stop” input (terminal 1 to 7 or terminal 35).



? The display blinks and indicates E 52.

! The BCU is permanently reset by remote reset.

- Check remote reset activation (default terminal = 2 or bus).
- Apply voltage to terminal 2 only for reset, approx. 1 second.

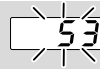

? The display blinks and indicates E 53.

! The time between two starts is less than the min. time (timing cycle).

- Comply with max. number of start-ups (n) per minute:

t _{SA} [s]	Device type ¹⁾		Max. number [n/min]
3	BCU..Q1	BCU..W1	6
5	BCU..Q1	BCU..W1	6
10	BCU..Q1	BCU..W1	3
3	BCU..Q2	BCU..W2	3
5	BCU..Q2	BCU..W2	2
10	BCU..Q2	BCU..W2	1
3	BCU..Q3	BCU..W3	6
5	BCU..Q3	BCU..W3	4
10	BCU..Q3	BCU..W3	3
3	BCU..Q8	BCU..W8	4
5	BCU..Q8	BCU..W8	3
10	BCU..Q8	BCU..W8	2

¹⁾ Ignition transformer ID numbers:

BCU..Q1: 34340581, BCU..Q2: 34340582

BCU..Q3: 34340583, BCU..Q8: 34340584

BCU..W1: 34340585, BCU..W2: 34340586

BCU..W3: 34340587, BCU..W8: 34340588



? The display blinks and indicates E 54.

! Faulty feedback signal of the control element position for ignition capacity.

- Check wiring from central actuator to BCU (terminal 39).
- Check whether parameter I072 = 13 (LDS ignition position check) and A089 = 2.

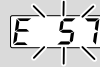

? The display blinks and indicates E 57.

! Faulty actuation of the input for high temperature operation. The BCU is prompted to go into menox mode, even though there is no signal for high temperature operation (> 750°C).

- Check the wiring.



? The display blinks and indicates E 80.

- !** Error in flame amplifier, burner 1.
 - Press the Reset/Information button on the BCU.



? The display blinks and indicates E 85.

- !** Error in flame amplifier, burner 2.
 - Press the Reset/Information button on the BCU.

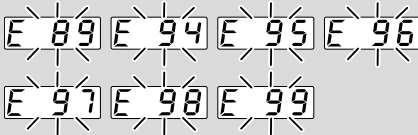

? The display blinks and indicates E 89, E 94, E 95, E 96, E 97, E 98 or E 99?

- !** System fault – the BCU has performed a safety shut-down. The cause may be a unit defect or abnormal EMC influence.
 - Ensure that the ignition cable has been installed properly – see page 5 (5 Cable selection and installation).
 - Ensure that the EMC regulations for the system are satisfied – particularly for systems with frequency converters – see page 5 (5 Cable selection and installation).
 - Reset the unit.
 - Disconnect the burner control unit from the mains supply and then switch it on again.
 - Check mains voltage and frequency.
 - If the measures described above do not help, the unit has probably suffered a hardware defect – remove the unit and return it to the manufacturer for inspection.



? The display blinks and indicates E 90.

- !** NTC error (internal temperature measurement).
 - Press the Reset/Information button on the BCU.

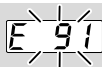

? The display blinks and indicates E 91.

- !** Voltage is applied to the ignition output.

- Check the wiring and ensure that the voltage outputs and inputs have the same polarity and are not reversed.

! Error at ignition output.

- Press the Reset/Information button on the BCU.



? The display blinks and indicates E 92.

! Error in communication with flame amplifier module.

- Press the Reset/Information button on the BCU.

! Fuse F3 defective.

- Replace fuse F3.

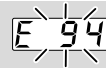

? The display blinks and indicates E 94.

! Error at the digital inputs.

- Press the Reset/Information button on the BCU.

! DC voltage is supplied to the inputs.

! The signal inputs and L are supplied with different phases of a three-phase current system.

- Check the wiring and ensure that the device and the inputs are supplied with the same phase.

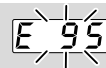

? The display blinks and indicates E 95.

! Error at the digital outputs.

- Press the Reset/Information button on the BCU.

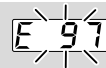

? The display blinks and indicates E 97.

! No PCC.

- Insert compatible PCC.

! Contact problems on the power module.

- Remedy contact problems.

! Power module is defective.

- Replace power module.
- If the measures described above do not help, the unit has probably suffered a hardware defect – remove the unit and return it to the manufacturer for inspection.



? The display blinks and indicates E R c.

- ! No "Minimum capacity reached" signal from actuator.
 - Check the butterfly valve and the function of the limit switches in the actuator.
 - Check the wiring.
 - Check the actuator.
 - If the fault cannot be remedied by doing this, remove the unit and return it to the manufacturer for inspection.



? The display blinks and indicates E R o.

- ! No "Maximum capacity reached" signal from actuator.
 - Check the butterfly valve and the function of the limit switches in the actuator.
 - Check the wiring.
 - Check the actuator.
 - If the fault cannot be remedied by doing this, remove the unit and return it to the manufacturer for inspection.



? The display blinks and indicates E R i.

- ! No "Ignition capacity reached" signal from actuator.
 - Check the butterfly valve and the function of the limit switches in the actuator.
 - Check the wiring.
 - Check the actuator.
 - If the fault cannot be remedied by doing this, remove the unit and return it to the manufacturer for inspection.

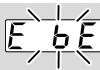

? The display blinks and indicates E b E.

- ! Internal communication with bus module has suffered a fault.
 - Check bus module connection.
 - Connected control elements must be equipped with protective circuits in accordance with the manufacturer's instructions.
- This prevents high voltage peaks which can cause malfunctioning of the BCU.
 - Use interference-suppressed terminal boots (1 kΩ).

- If the fault cannot be remedied by doing this, remove the unit and return it to the manufacturer for inspection.

- ! Bus module is defective.
 - Replace the bus module.

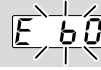

? The display blinks and indicates E b 0.

- ! Faulty connection to master.
 - Check the connection.
 - Check whether the slave is configured in the master.

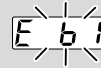

? The display blinks and indicates E b 1.

- ! Incorrect K-SafetyLink address.
 - Check that the set address matches the address configured for K-SafetyLink.
 - Only use addresses in the range of 0x001 to 0xFEf.

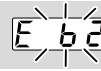

? The display blinks and indicates E b 2.

- ! Plausibility check failed, K-SafetyLink configuration invalid.
 - Check SafetyLink configuration in BCSofT and transfer to the device again.

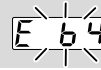

? The display blinks and indicates E b 4.

- ! K-SafetyLink awaiting configuration.
 - Create a SafetyLink project with BCSofT and transfer the configuration to the device.

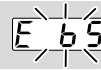

? The display blinks and indicates E b 5.

- ! Slave configuration check not executed or failed.
 - Start and complete the verification of the configuration in the SafetyLink master assigned to the slave using BCSofT.

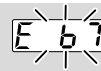

? The display blinks and indicates E b 7.

- ! Incompatible or defective bus module.

- Replace bus module with a functional device (for K-SafetyLink).

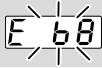

? The display blinks and indicates E b 8.

- ! The unit is accessed by two or more devices with the same address.
 - Check the configuration in BCSofT.
- Each device must have a unique address.
 - Remove any device with an incorrect address configuration from the network or reconfigure it.
 - Check the correct assignment of the master and slave devices using the verification procedure.

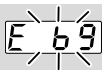

? The display blinks and indicates E b 9.

- ! The unit is accessed by one or more devices with unknown addresses.
 - Check the configuration in BCSofT.
- Each slave may only be assigned to one master.
 - Remove any device with an incorrect address configuration from the network or reconfigure it.
 - Check the correct assignment of the master and slave devices using the verification procedure.



? The display blinks and indicates E c c.

- ! Incorrect or defective parameter chip card (PCC).
 - Only the intended parameter chip card is to be used.
- Upload the current parameter settings again.
 - Replace defective parameter chip card.

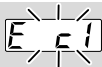

? The display blinks and indicates E c 1.

- ! No input signal from the valve proof of closure switch (POC) during standby.
 - Check the wiring.
 - Check parameterization of inputs at terminals 36, 37 and 38.
- Mains voltage must be supplied to the BCU (terminals 36, 37 and 38) if the valve is closed.
 - Check that the proof of closure switch and valve function perfectly, replace defective valves.



? The display blinks and indicates E c 8.

- ! The BCU is receiving no information as to whether the POC switch contact is still open.
 - Check the wiring.
 - Check parameterization of inputs at terminals 36, 37 and 38.
- There must be no mains voltage at the BCU (terminals 36, 37 and 38) during operation if the valve is open.
 - Check that the proof of closure switch and valve function perfectly, replace defective valves.



? The display blinks and indicates E d 0.

- ! The “no flow” state check of the air pressure switch has failed.
 - Check the function of the air pressure switch.
- Before the fan is switched on, there must be no High signal at the input for air monitoring (terminals 36/37) when air monitoring is activated.

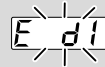

? The display blinks and indicates E d 1.

- ! The operating check of the air pressure switch has failed. The air monitor has not switched after activation of the air supply.
 - Check the air monitor wiring.
 - Check the air pressure switch setpoint.
 - Check the function of the fan or air supply.



? The display blinks and indicates E d P.

- ! The input signal (terminal 37) from the air pressure switch has dropped out during pre-purge.
 - Check the air supply during the purging process.
 - Check the electrical wiring of the air pressure switch.
 - Check voltage supply to terminal 37.
 - Check the air pressure switch setpoint.

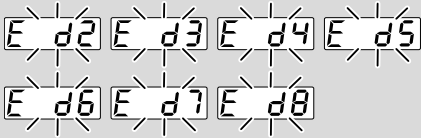

? **The display blinks and indicates E d 2, E d 3, E d 4, E d 5, E d 6, E d 7 or E d 8?**

! The input signal from the air pressure switch has dropped out during start-up/operation at program step X (02 to 08).

! Failure of the air supply at program step X.

- Check the air supply.
- Check the air pressure switch setpoint.



? **The display blinks and indicates n 0.**

! No connection established between BCU and PLC.

- Check the wiring.
- Check the PLC program to ensure that the network name and IP configuration of the BCU are valid.
- Switch on the PLC.

Or

? **A bus fault is indicated on the automation system.**

! The PROFIBUS DP data traffic has suffered a fault.

! Bus cable interrupted.

- Check cable.

! Incoming and outgoing bus cables confused in the plug.

- Check the wiring.

! A and B cables confused.

- Check the wiring.

! Terminal resistors connected incorrectly.

- Switch on the terminal resistors on the first and last subscriber in the segment and switch them off for all other subscribers.

! Incorrect PROFIBUS address set.

- Correct the address setting – switch the unit off and then on again to save the address.

! Bus cables too long.

- Reduce cable length or baud rate – see page 14 (9 Commissioning).

→ If the transfer rate is reduced, remember that this will increase the signal running times to and from the individual units.

! Poor shielding.

- Check whether the shield is connected to the shield clips in the PROFIBUS DP plugs in full and over a wide area.

! Poor equipotential bond.

- Check whether the PROFIBUS DP shield is connected at all points to the same ground potential via the grounding system of the units.
- If necessary, an equipotential bonding cable must be laid.

→ If faults occur sporadically in the PROFIBUS DP system, and are only indicated briefly in the bus master, the following points in particular should be checked:

- Terminal resistors,
- Shield,
- Cable lengths/routes,
- Equipotential bond,
- Use of interference-suppressed spark electrode terminal boots (1 kΩ).

→ For information on planning and the structure of a PROFINET network and the components to be used (e.g. cables, lines and switches), see www.profibus.com or the instructions for the automation system.



? **The display blinks and indicates n 1.**

→ Fault occurs on devices with fieldbus communication with address check (A080 = 1) only.

! An invalid or incorrect address has been set on the bus module.

- Assign the correct address (001 to FEF) to the bus module.

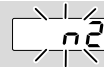

? **The display blinks and indicates n 2.**

! The bus module has received an incorrect configuration from the PLC.

- Check whether the correct GSD file was imported.



? **The display blinks and indicates n 3.**

→ Fault occurs on devices with fieldbus communication with address check (A080 = 1) only.

! The BCU has been assigned an invalid network name or has not been assigned a network name in the PLC.

- Assign a network name corresponding to the default network name (bcu-460-xxx) or use the default name as a suffix of an individually assigned name in the following form: "individual-partofnamebcu-460-xxx".

→ "xxx" stands for the address set on the device (e.g. 4A5).



? The display blinks and indicates n 4.

- ! PLC in STOPP position.
- Check whether the PLC can be started.



? The display blinks and indicates OT.

- ! The ambient temperature is too high for the BCU (excessive temperature).
- The display disappears as soon as the temperature has dropped to the specified setpoint.



? The display blinks and indicates UT.

- ! The ambient temperature is too low for the BCU (insufficient temperature).
- The display disappears as soon as the temperature has risen to the specified setpoint again.

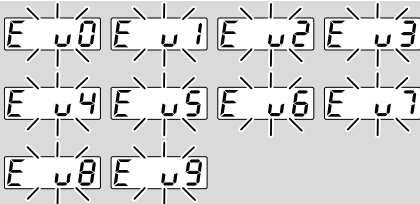

? The display blinks and indicates E u 1, E u 2, E u 3, E u 4, E u 5, E u 6, E u 7, E u 8 or E u 9?

- ! The signal for monitoring the min. gas pressure (terminals 36, 37 and 38) has dropped out at program step X (00 to 09).
- Check the wiring.
 - Check the gas pressure.

Replacing the fuse

- The device fuses F1, F2 and F3 can be removed for inspection.
- The fuses are located under the power module.

⚠ CAUTION

BCU..E0 and BCU..E1 do not have the same power supply connection.

Always replace fuse F1 or F2 such that the required power supply is ensured:

- **F1 = BCU..E1:** power supply via L1.
- **F2 = BCU..E0:** power supply via safety interlocks.

1 Disconnect the system/BCU from the electrical power supply.

2 Open the BCU.

3 Remove the power module.

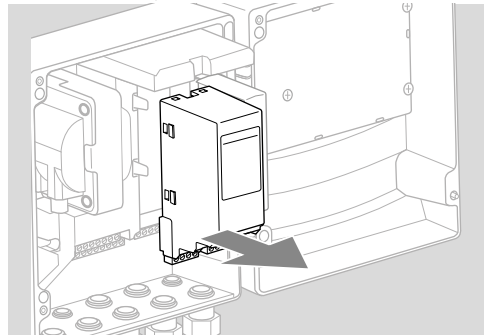

4 Remove fuse F1, F2 or F3 and check for correct functioning.

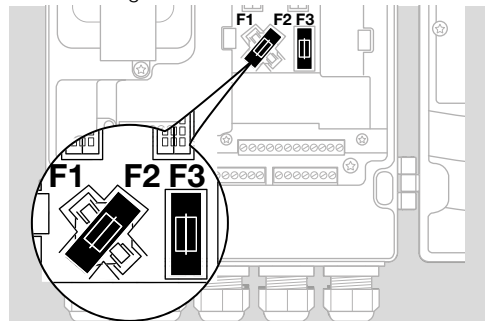

- When replacing the fuse, use only the approved fuse type:

F1, F2, F3: T 3.15A H,
pursuant to IEC 60127-2/5.

12 READING OFF THE FLAME SIGNAL, FAULT MESSAGES AND THE PARAMETERS

- If the unit is switched on, information about the flame signal intensity, the last 10 event messages (e.g. Power ON, error E002) and the parameter values can be read off by repeatedly pressing the Reset/Information button.

Display	Information
<i>F1</i> <i>F2*</i>	Flame signal intensity Burner 1 Burner 2*
<i>H0</i> to <i>H9</i>	Last event message to tenth to last event message
<i>001</i> to <i>999</i>	Parameter 001 to Parameter 999

* Only on BCU 480

- 1 Press the Reset/Information button for approx. 2 s until the display indicates *F1*.
 - 2 Release the button. The display indicates the flame signal intensity in μA .
 - 3 Press the Reset/Information button again for 2 s to go to the next item of information (event message, parameter value).
- Each time the button is released, the corresponding event message or parameter value is displayed.
 - To go to one of the last event messages or to a parameter more quickly, hold the Reset/Information button pressed down for longer (≥ 2 s).
 - If the button is pressed briefly, the display indicates what parameter number is currently being displayed.
 - The normal program status is displayed again approx. 60 seconds after the last time the button is pressed.
 - For the parameters and the corresponding values, see Technical Information bulletins BCU 46x and BCU 480.

13 PARAMETERS AND VALUES

Application parameters

Parameter	
No.	Name Value
R001	Switch-off threshold 1 2-20 = μ A
R002	Switch-off threshold 2 2-20 = μ A
R003	Flame simulation check 0 = In standby 1 = On start-up
R006	High temperature operation 0 = Off 2 = Burner 1 UVS Burner 2 UVS 3 = Continuous operation 5 = Burner 1 UVS Burner 2 ionization
R007	Burner 1 start-up attempts 1 = 1 start-up attempt 2 = 2 start-up attempts 3 = 3 start-up attempts
R008	Burner 2 start-up attempts 1 = 1 start-up attempt 2 = 2 start-up attempts 3 = 3 start-up attempts
R009	Restart 0 = Off 1 = Burner 1 2 = Burner 2 3 = Burner 1 and burner 2 (pilot and main burners) 4 = Burner 1 max. 5 x in 15 min. 5 = Burner 2 max. 5 x in 15 min. 6 = Burner 1 & 2 max. 5 x in 15 min.
R016	Delayed low air pressure protection 0 = Off 1 = On
R019	Safety time during operation 0; 1; 2; 3; 4 = Time in seconds
R028	Pre-ventilation/flameless 0-250 = Time in seconds
R029	Cooling priority 0 = Start-up overrides cooling 1 = Cooling overrides start-up
R030	Staged cooling 0 = Start-up overrides cooling 1 = Stage 2 via signal at terminal 5 2 = After delay time
R031	Staged cooling delay 0-6000 = Time in seconds
R034	Pre-purge time t_{PV} 0-6000 = Time in seconds
R036	Pre-ventilation 0-250 = Time in seconds
R039	Over-run time 0-60 = Time in seconds
R041	Running time selection 0 = Off; position check 1 = On; for min./max. capacity 2 = On; for maximum capacity 3 = On; for minimum capacity

Parameter	
No.	Name Value
R042	Running time 0-250 = Time in seconds
R043	Over-run 0 = Off 1 = Post-ventilation 2 = Low fire; actuator feedback 3 = Low fire; time-bound
R044	Controller enable signal delay time t_{FF} 0-250 = Time in seconds
R048	Air actuator control 0 = Opens on external activation 1 = Opens with gas stage 1 2 = Opens with gas stage 2 4 = Opens with V4 burner 1 6 = Opens with gas stage 3
R049	Air actuator on start-up can be activated externally 0 = Cannot be activated 1 = Can be activated externally
R050	Air actuator in the event of fault 0 = Cannot be activated 1 = Can be activated externally
R051	Valve proving system 0 = Off 1 = Tightness test before start-up 2 = Tightness test after shut-down 3 = Tightness test before start-up and after shut-down
R052	Relief valve (VPS) 0 = V0 1 = V1 2 = V2 3 = V3 4 = V4 5 = V5
R056	Measurement time for V_{p1} 0-3600 = Time in seconds
R059	Valve opening time 1 t_{L1} 2-25 = Time in seconds
R060	POC test period 0-250 = Time in seconds
R061	Minimum operating time t_B 0-6000 = Time in seconds
R062	Minimum pause time t_{MP} 0-3600 = Time in seconds
R064	Flameless operation 0 = On next burner start 1 = Immediate burner start 2 = Immediate switchover
R067	Operating time in Manual mode 0 = Unlimited 1 = 5 minutes
R074	Combustion mode 0 = Flame mode 1 = Flameless/menox® 2 = HT without ignition 3 = HT without burner 1 start

Parameter	
No.	Name Value
<i>R075</i>	Air actuator (bus) <i>0</i> = Off <i>1</i> = MAX to MIN <i>2</i> = MAX to LOW FIRE <i>3</i> = MAX to IGNITION <i>4</i> = MAX to MIN; reduced pre-purge flow rate <i>5</i> = MAX to ZÜND; reduced pre-purge flow rate
<i>R076</i>	Function of V5 <i>0</i> = Off <i>1</i> = Flame mode <i>2</i> = Flameless operation <i>3</i> = Operation
<i>R077</i>	Auxiliary gas function <i>0</i> = Off <i>1</i> = Flame mode <i>2</i> = Flameless operation <i>3</i> = Operation
<i>R078</i>	Burner application <i>0</i> = Burner 1 <i>1</i> = Burner 1 with pilot gas <i>2</i> = Burner 1 & burner 2 <i>3</i> = Br. 1 & Br. 2 with pilot gas <i>4</i> = Two-stage burner 1 <i>5</i> = Br. 1 & two-stage br. 2 <i>13</i> = Flameless 1/0 with 2 gas paths
<i>R079</i>	Pilot burner <i>0</i> = With shut-down <i>1</i> = Continuous operation <i>2</i> = With shut-down & restart
<i>R080</i>	Fieldbus communication <i>0</i> = Off <i>1</i> = With address check <i>2</i> = No address check
<i>R081</i>	K-SafetyLink <i>0</i> = Off <i>1</i> = On
<i>R085</i>	Safety interlocks (bus) <i>0</i> = Off <i>1</i> = Via FS bus <i>2</i> = Via terminal <i>3</i> = Via NFS bus <i>4</i> = Via FS bus or terminal <i>5</i> = Via FS bus and terminal
<i>R087</i>	Purge (bus) <i>0</i> = Off <i>1</i> = Via FS bus <i>2</i> = Via terminal <i>3</i> = Via NFS bus <i>4</i> = Via NFS, FS bus or terminal <i>5</i> = Via NFS, FS bus and terminal
<i>R088</i>	High temperature operation (bus) <i>0</i> = Off <i>1</i> = Via FS bus <i>2</i> = Via terminal <i>3</i> = Via NFS bus <i>4</i> = Via FS bus or terminal <i>5</i> = Via FS bus and terminal

Parameter	
No.	Name Value
<i>R089</i>	LDS (bus) <i>0</i> = Off <i>1</i> = Via FS bus <i>2</i> = Via terminal <i>3</i> = Via NFS bus <i>4</i> = Via FS bus or terminal <i>5</i> = Via FS bus and terminal
<i>R093</i>	Pre-ignition time <i>0-5</i> = Time in seconds
<i>R094</i>	Safety time 1 t_{SA1} <i>2-15</i> = Time in seconds
<i>R095</i>	Flame proving period 1 t_{FS1} <i>0-25</i> = Time in seconds
<i>R096</i>	Safety time 2 t_{SA2} <i>2-10</i> = Time in seconds
<i>R097</i>	Flame proving period 2 t_{FS2} <i>0-25</i> = Time in seconds
<i>R101</i>	Function of sensor 1 <i>0</i> = No function <i>1</i> = APS Purge <i>4</i> = APS Stage 2 <i>5</i> = APS Purge & Stage 2 <i>6</i> = APS Stage 1 & Stage 2 <i>7</i> = APS Purge & Stage1 & Stage2 <i>8</i> = APS Flameless <i>9</i> = APS Purge & Flameless <i>12</i> = APS Stage 2 & Flameless <i>13</i> = APS Purge&Stage2&Flameless <i>14</i> = APS Stage 1&2 & Flameless <i>15</i> = APS Purge & Stage1&2 & Flameless <i>34</i> = APS External High <i>35</i> = APS External High & Purge <i>48</i> = POC V1 <i>49</i> = POC V2 <i>50</i> = POC V3 <i>51</i> = POC V4 <i>52</i> = POC V5 <i>53</i> = TC <i>54</i> = GPS Flame mode <i>55</i> = GPS Flameless operation <i>56</i> = GPS Operation
<i>R102</i>	Function of sensor 2 Parameter values, see parameter A101
<i>R103</i>	Function of sensor 3 Parameter values, see parameter A101
<i>R129</i>	Active cooling outputs <i>0</i> = Off <i>1</i> = Air actuator <i>2</i> = Cooling air <i>3</i> = Air actuator & cooling air <i>4</i> = Flue gas <i>5</i> = Air actuator & flue gas <i>6</i> = Cooling air & flue gas <i>7</i> = Air actuator & cooling air & flue gas
<i>R139</i>	Over-run time, flameless t_{NL} <i>0-60</i> = Time in seconds

Interface parameters

→ Interface parameters I040 to I099 are set at the factory and normally do not need to be adjusted.

CAUTION

Changing the default settings of the interface parameters will change the functions of the inputs at terminals 1 to 41 and terminals 85 to 90, see page 7 (7 Connection diagram).

Parameter	
No.	Name Value
I004	Flame control 0 = Ionization 1 = UVS 2 = UVC 3 = Ionization 1 and UVS 2 4 = Ionization 1 and UVC 2 5 = UVS 1 and ionization 2 6 = UVC 1 and UVC 2 7 = UVC 1 and ionization 2 8 = UVC 1 und UVS 2
I020	Air actuator 1 = IC 20 2 = IC 40 3 = RBW 4 = Frequency converter 5 = Air valve
I040	Function of terminal 64 0 = Off 1 = Controller enable 2 = V5 3 = Bus output 1
I050	Contact 80, 81/82 function 0 = Off 1 = Ready signal 2 = Air signal 3 = Purge signal 4 = Cooling air valve 5 = Flue gas valve 6 = Fault signal 7 = Burner 1 operating signal 8 = Burner 2 operating signal
I051	Contact 90, 91/92 function Parameter values, see parameter I050
I052	Contact 95/96 function Parameter values, see parameter I050
I053	Contact 95/97 function Parameter values, see parameter I050
I054	Contact 85/86, 87 function Parameter values, see parameter I050

Parameter	
No.	Name Value
I061	Function of input 1 0 = Off 1 = Sensor 1 2 = Sensor 2 3 = Sensor 3 4 = Safety interlocks 5 = Air 6 = Cooling air 7 = Air actuator R1 8 = Air actuator R2 9 = Start 1 10 = Start 2 11 = Reset 12 = Purge 13 = LDS start-up conditions 14 = High temperature operation 15 = Flame mode 16 = Flameless operation 17 = menox 19 = Auxiliary gas
I062	Function of input 2 Parameter values, see parameter I061
I063	Function of input 3 Parameter values, see parameter I061
I064	Function of input 4 Parameter values, see parameter I061
I065	Function of input 5 Parameter values, see parameter I061
I066	Function of input 6 Parameter values, see parameter I061
I067	Function of input 7 Parameter values, see parameter I061
I068	Function of input 35 Parameter values, see parameter I061
I069	Function of input 36 Parameter values, see parameter I061
I070	Function of input 37 Parameter values, see parameter I061
I071	Function of input 38 Parameter values, see parameter I061
I072	Function of input 39 Parameter values, see parameter I061
I073	Function of input 40 Parameter values, see parameter I061
I074	Function of input 41 Parameter values, see parameter I061

14 LEGEND

Symbol	Description
	Ready for operation
	Safety interlocks (limits)
	Control element position check
	Controlled air flow
	Remote reset
LDS	Safety limits (limits during start-up)
	Gas valve
	Air valve
	Air/gas ratio control valve
	Burner
	Purge
	External air control
	Burner flame signal
	Burner operating signal
	Fault signal
Start 1	BCU start-up signal
	Input for Flameless/menox® mode signal
	Input for high temperature operation
	Pressure switch for tightness control (TC)
	Pressure switch for maximum pressure
	Pressure switch for minimum pressure
	Differential pressure switch
	Actuator with butterfly valve
	Valve with proof of closure switch
	Fan
	Three-point step switch
	Input/Output, safety circuit
TC	Tightness control
$p_U/2$	Half of the inlet pressure
p_U	Inlet pressure
p_d	Outlet pressure
V_{p1}	Test volume
I_N	Current consumption of sensor/ contactor

Symbol	Description
t_L	Tightness control opening time
t_M	Measurement time during tightness test
t_P	Tightness control test period (= $2 \times t_L + 2 \times t_M$)
t_{FS}	Flame proving period
t_{MP}	Minimum pause time
t_{NL}	Over-run time
t_{SA}	Safety time on start-up
t_{SB}	Safety time during operation
t_{VZ}	Pre-ignition time
t_{PV}	Pre-purge time
t_{RF}	Controller enable signal delay time

15 TECHNICAL DATA

WARNING

Information pursuant to REACH Regulation No. 1907/2006, Article 33.

The device contains substances of very high concern which are listed in the Candidate List of the European REACH Regulation No. 1907/2006.

15.1 Ambient conditions

Avoid direct sunlight or radiation from red-hot surfaces on the unit.

Avoid corrosive influences, e.g. salty ambient air or SO₂.

The unit may only be stored/installed in enclosed rooms/buildings that are not accessible to the public.

This unit is not suitable for cleaning with a high-pressure cleaner and/or cleaning products.

Ambient temperature:

-20 to +70°C (-4 to +158°F),

no condensation permitted.

Enclosure: IP 65 pursuant to IEC 529.

Safety class: 1.

Pollution degree: internal environment: 2, external environment: 4.

Permitted operating altitude: < 2000 m AMSL.

15.2 Mechanical data

Weight: 5.5 kg.

Dimensions (W x H x D): 200 x 230 x 135 mm.

Connections:

Screw terminals:

nominal cross-section 2.5 mm²,

wire cross-section (rigid) min. 0.2 mm²,

wire cross-section (rigid) max. 2.5 mm²,

wire cross-section AWG/kcmil min. 24,

wire cross-section AWG/kcmil max. 12.

Spring force terminals:

nominal cross-section 2 x 1.5 mm²,

wire cross-section min. 0.2 mm²,

wire cross-section AWG min. 24,

wire cross-section AWG max. 16,

wire cross-section max. 1.5 mm².

15.3 Electrical data

Mains voltage:

BCU..Q: 120 V AC, -15/+10%, 50/60 Hz, ± 5%,

BCU..W: 230 V AC, -15/+10%, 50/60 Hz, ± 5%.

Power consumption: 10 VA,

for grounded and ungrounded mains.

Flame control:

with UV sensor or flame rod.

For intermittent or continuous operation.

Flame signal current:

ionization control: 1–25 A,

UV control: 1–35 A.

ionization/UV cable:

max. 50 m (164 ft).

Contact rating:

Valve outputs V1, V2, V3 and V4 (terminals 60, 61, 62, 63 and 64): max. 1 A each, cos φ = 1.

Actuator outputs (terminals 65, 66 and 67): max. 1 A each, cos φ = 1.

Air valve output (terminal 65): max. 1 A, cos φ = 1.

Ignition transformer (terminal 51): max. 2 A.

Total current for the simultaneous activation of the valve outputs (terminals 60, 61, 62, 63 and 64) and of the ignition transformer (terminal 51), protected by F1/F2: max. 2.5 A.

Total current for the simultaneous activation of the outputs for air valve and actuator (terminals 65, 66 and 67): max. 2 A.

Signalling contact for operating and fault signals: max. 1 A, cos φ = 1 (external fuse required).

Number of operating cycles: the fail-safe outputs (valve outputs V1, V2, V3 and V4) and the air valve output are monitored for correct functioning and are thus not subject to a max. number of operating cycles.

Control actuator (terminals 60, 61, 62, 63 and 64): 1,000,000,

signalling contact for operating signals (terminals 95, 96 and 97):

1,000,000,

signalling contact for fault signals (terminals 80, 81 and 82):

max. 25,000,

On/Off button:

max. 10,000,

Reset/Information button:

max. 10,000.

Input voltage of signal inputs:

Rated value	120 V AC	230 V AC
Signal "1"	80–132 V	160–253 V
Signal "0"	0–20 V	0–40 V

Signal input current:

Signal "1"	max. 5 mA
------------	-----------

Fuses, replaceable, F1/F2/F3: T 3.15A H, pursuant to IEC 60127-2/5.

Does not meet the requirements for safety extra-low voltage (SELV/PELV).

15.4 Designed lifetime

This information on the designed lifetime is based on using the product in accordance with these operating instructions. Once the designed lifetime has been reached, safety-relevant products must be replaced.

Designed lifetime (based on date of manufacture): 10 years.

You can find further explanations in the applicable rules and regulations and on the afecor website (www.afecor.org).

This procedure applies to heating systems. For thermostating equipment, observe local regulations.

16 SAFETY INSTRUCTIONS

Scope of application: as set out in “Industrial thermoprocessing equipment – Part 2: Safety requirements for combustion and fuel handling systems” (EN 746-2) when used with fuels and oxidants. The BCU 4 is suitable for continuous operation (pursuant to EN 298:2012-12, Section 3.126) and for intermittent operation (pursuant to EN 298:2012-11, Section 3.127).

Action:

Type 2 pursuant to EN 60730-1.

Behaviour under fault conditions:

The output signals are switched off electronically in accordance with the criteria of automatic action type B.V.AC.AD.AF.AG.AH (pursuant to EN 60730-2-5:2015, Section 6.4.3.).

Maximum reaction time in the event of a flame failure:

This corresponds to the safety time during operation and can be parameterized to between 1 and 4 s.

Software class:

Corresponds to software class C which operates in a similar double-channel architecture with comparison.

Interfaces

Type of wiring:

Attachment type X to EN 60730-1.

Grounding: via PE wire connection.

Internal voltages are neither SELV nor PELV.

Floating contacts meet the requirements for SELV.

Communication

Safety over EtherCAT® technology (FSoE, FailSafe over EtherCAT) is used for K-SafetyLink communication. Safety over EtherCAT® is a registered trademark and patented technology licensed by Beckhoff Automation GmbH, Germany.



The K-SafetyLink technology complies with SIL 3 in accordance with EN 61508 and is standardized pursuant to IEC 61784-3-12 and ETG 5100.

Safety over EtherCAT® uses the fail-safe principle which means that a safe state is restored in the case of an inactive signal. In the case of communication errors, all signals are interpreted as inactive. Safety-relevant data are transmitted on the basis of the black channel principle.

All devices connected to the communications system must meet the requirements for safety extra-low voltage (SELV/PELV) (EN 60730-1).

The end user must ensure the unique setting and parameterization of the SafetyLink address within the Ethernet network.

The setting and assignment of the addresses must be verified before commissioning using the verification procedure described in the extended documentation.

17 LOGISTICS

Transport

Protect the unit from external forces (blows, shocks, vibration).

Transport temperature: see page 31 (15 Technical data).

Transport is subject to the ambient conditions described.

Report any transport damage on the unit or packaging without delay.

Check that the delivery is complete.

Storage

Storage temperature: see page 31 (15 Technical data).

Storage is subject to the ambient conditions described.

Storage time: 6 months in the original packaging before using for the first time. If stored for longer than this, the overall service life will be reduced by the corresponding amount of extra storage time.

18 ACCESSORIES

18.1 BCSoft4

The current software can be downloaded from our Internet site at www.docuthek.com. To do so, you need to register in the DOCUTHEK.

18.2 Opto-adapter PCO 200

Including BCSoft CD-ROM,
Order No.: 74960625.

18.3 Fastening set

To ensure a gap between the BCU and the mounting surface with higher temperatures.

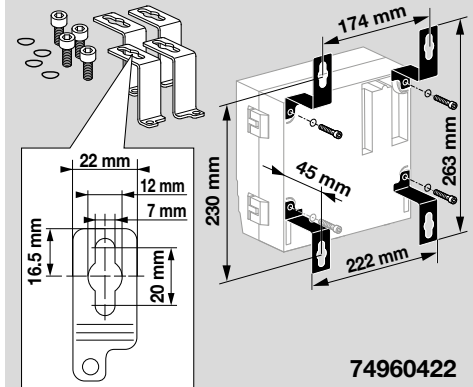

18.4 External securing bars

The external securing bars are screwed on from inside the unit.

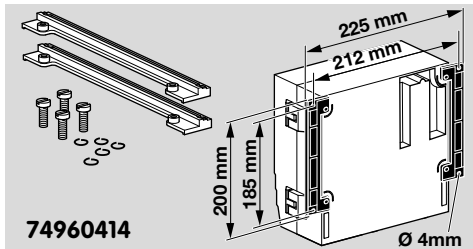

18.5 Bus module BCM 400

Communication interface for connecting the BCU to an automation system.

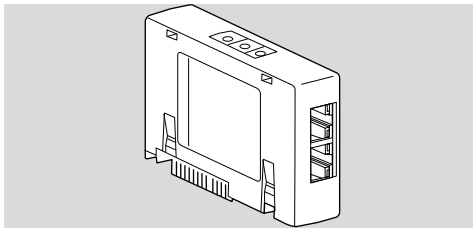

Bus module	Bus system	Order No.
BCM 400S0B1/1-1	PROFIBUS	74960730
BCM 400S0B1/1-0	PROFIBUS	74960690
BCM 400S0B2/3-0	PROFINET	74960691
BCM 400S0B3/3-0	EtherNet/IP	74960692

18.6 Set of language stickers

To affix to the cover, with program step/fault message descriptions in English, French, Dutch, Spanish and Italian,
Order No. 34339360.

19 CERTIFICATION

Declaration of conformity



We, the manufacturer, hereby declare that the products BCU 460, BCU 465 and BCU 480 comply with the requirements of the listed Directives and Standards.

Directives:

- 2014/35/EU – LVD¹⁾
- 2014/30/EU – EMC

Regulation:

- (EU) 2016/426 – GAR

Standards:

- EN 298:2012
- EN 1643:2014
- EN 60730-2-5
- EN 61508:2010, suitable for SIL 3

The production is subject to the surveillance procedure pursuant to Regulation (EU) 2016/426 Annex III paragraph 3.

Elster GmbH

Scan of the Declaration of conformity (D, GB) – see www.docuthek.com

¹⁾ There is no need for any additional EMC measurement when installed.

SIL, PL

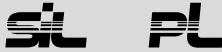

For systems up to SIL 3 pursuant to EN 61508. Pursuant to EN ISO 13849-1, Table 4, the BCU can be used up to PL e.

Safety-specific characteristic values	
Diagnostic coverage DC	91.3%
Type of subsystem	Type B to EN 61508-2:2010
Mode of operation	High demand mode pursuant to EN 61508-4:2010
Mean probability of dangerous failure PFH _D	32.9 × 10 ⁻⁹ 1/h on BCU 4xx..F1, 38.3 × 10 ⁻⁹ 1/h on BCU 4xx..F3
Mean time to dangerous failure MTTF _d	1/PFH _D
Safe failure fraction SFF	99.0%

Mean probability of dangerous failure PFH_D (70°C) of individual safety functions

Burner control with 2 gas valves	23.2 × 10 ⁻⁹ 1/h
Burner control with 3 gas valves	28.5 × 10 ⁻⁹ 1/h
Valve check	15.0 × 10 ⁻⁹ 1/h
Proof of closure	3.3 × 10 ⁻⁹ 1/h
Flame control	8.4 × 10 ⁻⁹ 1/h
Temperature monitoring	2.2 × 10 ⁻⁹ 1/h
Air pressure switch monitoring	3.3 × 10 ⁻⁹ 1/h
Gas pressure switch monitoring	3.3 × 10 ⁻⁹ 1/h
Purge with air pressure switch	4.3 × 10 ⁻⁹ 1/h
K-SafetyLink	1.0 × 10 ⁻⁹ 1/h
Safety interlocks (limits)	2.2 × 10 ⁻⁹ 1/h
Valve check with redundant pressure switch	12.9 × 10 ⁻⁹ 1/h
Air pressure switch monitoring with red. pressure switch	1.3 × 10 ⁻⁹ 1/h
Gas pressure switch monitoring with red. pressure switch	1.3 × 10 ⁻⁹ 1/h
Purge with red. air pressure switch	2.3 × 10 ⁻⁹ 1/h

FM approved



Factory Mutual (FM) Research Class: 7610 “Combustion Safeguards and Flame Sensing Systems”.

Suitable for applications pursuant to NFPA 86.

19.1 Eurasian Customs Union



The products BCU 460, BCU 465, BCU 480 meet the technical specifications of the Eurasian Customs Union.

20 DISPOSAL

Devices with electronic components:

WEEE Directive 2012/19/EU – Waste Electrical and Electronic Equipment Directive



At the end of the product life (number of operating cycles reached), dispose of the packaging and product in a corresponding recycling centre. Do not dispose of the unit with the usual domestic refuse. Do not burn the product.

On request, old units may be returned carriage paid to the manufacturer in accordance with the relevant waste legislation requirements.

FOR MORE INFORMATION

The Honeywell Thermal Solutions family of products includes Honeywell Combustion Safety, Eclipse, Exothermics, Hauck, Kromschöder and Maxon. To learn more about our products, visit ThermalSolutions.honeywell.com or contact your Honeywell Sales Engineer.

Elster GmbH
Strotheweg 1, D-49504 Lotte
T +49 541 1214-0
hts.lotte@honeywell.com
www.kromschroeder.com

Global centralized service deployment coordination:
T +49 541 1214-365 or -555
hts.service.germany@honeywell.com

Translation from the German
© 2023 Elster GmbH

Honeywell
krom
schröder